

$N = 2$ dualities

Davide Gaiotto

*School of Natural Sciences, Institute for Advanced Study,
Princeton, NJ 08540, USA*
dgaiotto@ias.edu

ABSTRACT: We study the generalization of S-duality and Argyres-Seiberg duality for a large class of $N = 2$ superconformal gauge theories. We identify a family of strongly interacting SCFTs and use them as building blocks for generalized superconformal quiver gauge theories. This setup provides a detailed description of the “very strongly coupled” regions in the moduli space of more familiar gauge theories. As a byproduct, we provide a purely four dimensional construction of $N = 2$ theories defined by wrapping M5 branes over a Riemann surface.

Contents

1. Outline	1
2. $SU(2)$ generalized quivers	4
2.1 S-duality	4
2.2 SW curves	12
2.3 An explicit construction from the A_1 $(2,0)$ six dimensional SCFT	20
3. $SU(3)$ generalized quivers	23
3.1 Argyres-Seiberg duality	23
3.2 SW curves	31
3.3 An explicit construction from the A_2 $(2,0)$ six dimensional SCFT	38
4. $SU(N)$ generalized quivers	39
4.1 Intermission	39
4.2 Canonical form	40
4.3 The linear quivers	46
4.4 Degeneration limits	50
5. Further developements	57

1. Outline

$\mathcal{N} = 2$ superconformal gauge theories have an interesting parameter space of exactly marginal gauge couplings. $N_f = 4$ $SU(2)$ gauge theory is an example: the gauge coupling (together with the theta angle) parameterizes the upper half plane H . The theory enjoys S-duality, which acts through the familiar $SL(2, Z)$ action on the upper half plane [1]. As a result, the actual parameter space of the SCFT is the quotient $H/SL(2, Z)$, and has a single “cusp” where an $SU(2)$ gauge group becomes arbitrarily weakly coupled. See fig. 1

The $SU(N)$ gauge theory with $N_f = 2N$ is also superconformal, and has an exactly marginal gauge coupling also valued in the upper half plane. S-duality only acts as a proper subgroup $\Gamma_0(2)$ of $SL(2, Z)$ [2]. The quotient $H/\Gamma_0(2)$ includes both a traditional cusp where the $SU(N)$ gauge theory becomes arbitrarily weakly coupled, and a “very strongly coupled” cusp where the dynamics is in general unknown. See fig. 1. The authors of [3] gave a surprising interpretation of the very strongly coupled region for the $N_f = 6$ $SU(3)$ gauge theory. A dual weakly coupled $SU(2)$ gauge group emerges in the very strongly coupled region of the $SU(3)$ gauge theory. This $SU(2)$ gauge group is coupled to a famous rank one interacting $\mathcal{N} = 2$ SCFT with E_6 symmetry.

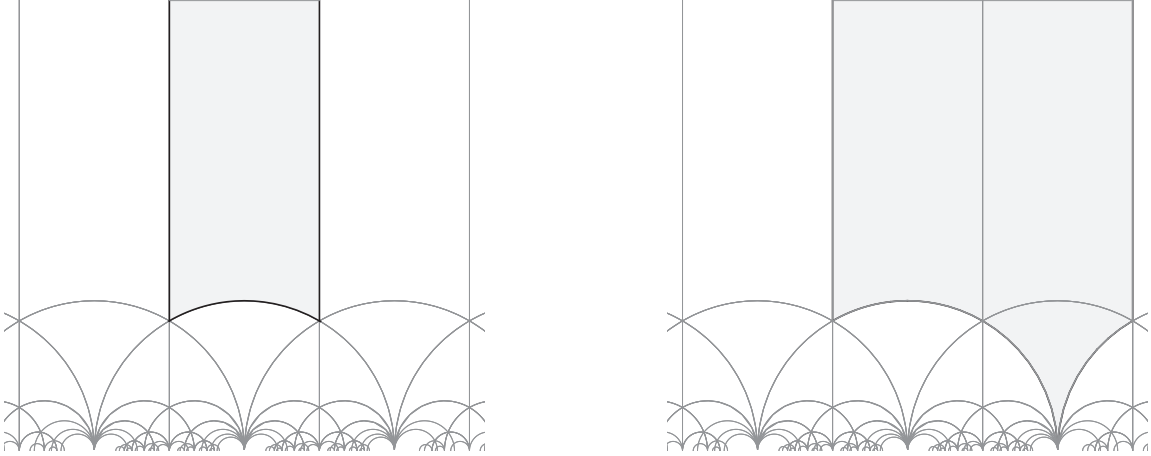

Figure 1: Left: the space of gauge couplings τ modulo S-duality for $SU(2)$ $N_f = 4$. The weakly coupled region is at $\tau \rightarrow i\infty$. Right: the space of gauge couplings τ modulo S-duality for $SU(N)$ $N_f = 2N$. The weakly coupled region is at $\tau \rightarrow i\infty$. The very strongly coupled region at $\tau \rightarrow 1$

Inspired by this result, we set up to explore the various strongly coupled cusps in the parameter space of very general $\mathcal{N} = 2$ superconformal gauge theories with $\prod SU(n_i)$ gauge groups. We find that in all cases a dual weakly coupled gauge groups emerge, coupled to a variety of “elementary” building blocks, interacting $\mathcal{N} = 2$ SCFTs with no exactly marginal deformations. We learn to combine these building blocks into a wider class of $\mathcal{N} = 2$ “generalized quivers” by gauging different combinations of the flavor symmetry groups. We conjecture a Seiberg-Witten curve for such generalized quivers and connect them into a network of S-dual theories. Furthermore, we argue that these generalized quivers provide a four dimensional definition of the “theory of N M5 branes wrapped on a Riemann surface”. Such theory is of some interest, as it has a known M-theory holographic dual description [4]. This fact provided a second important motivation for this work. Details of the holographic correspondence will be explored in the upcoming [5].

We use two main tools for our computation. The first is the general construction of [6], which provides us with the Seiberg Witten curve for any linear quiver of unitary gauge groups. This brane construction actually provides much more than the Seiberg Witten curve for the theories. It truly provides a recipe for constructing the four dimensional gauge theory as a compactification of the six dimensional $(2, 0)$ SCFT of A_{N-1} type. This information is encoded into a specific realization of the Seiberg-Witten curve as a N sheeted branched covering of a punctured complex sphere or torus, with a canonical choice of SW differential. Traditionally the SW curve only provides information about the massless abelian gauge theory in the IR, and may even be insufficient to distinguish distinct four dimensional theories. The full fibration instead identifies the four dimensional theory uniquely by its six-dimensional origin, encodes the BPS spectrum of the theory, and various other properties. This useful point of view has been developed in detail in [7].

While a symmetry of the SW curve is a circumstantial evidence of a duality, a symmetry which extends to the N sheeted covering structure is essentially a proof (albeit one which

depends on the existence and properties of the $(2, 0)$ theory and of certain codimension two defect operators). A great majority of known $\mathcal{N} = 2$ theories (and many previously unknown) admit a description in terms of the $(2, 0)$ ADE theories, but probably not all. It is not hard to produce certain quiver gauge theories which fall outside of the known brane constructions (See section 5). It would be interesting to study them further. In this paper we only consider the A-type $(2, 0)$ theory. It would be interesting to extend our work to the other types. See section 5 for more details and references. We will follow an “experimental” approach, constructing examples of increasing complexity and then decomposing them in simple building blocks at the cusps of the gauge coupling moduli space.

In section 2 we will consider superconformal quivers with $SU(2)$ gauge groups. The S-duality of $SU(2)$ with $N_f = 4$ extends in a surprising way to quivers of $SU(2)$ groups. Large families of different-looking quivers with the same gauge and flavor groups turn out to be dual descriptions of a single theory $\mathcal{T}_{n,g}[A_1]$, associated to a Riemann surface of genus g with n punctures $C_{n,g}$. We will identify the theory as the twisted compactification of the A_1 $(2, 0)$ six-dimensional CFT on $C_{n,g}$, in the presence of n defect operators. The Seiberg-Witten curve for the theory is a ramified double cover of $C_{n,g}$.

In section 3 we will consider superconformal quivers with $SU(3)$ (and possibly $SU(2)$) gauge groups. The Argyres-Seiberg duality of $SU(3)$ with $N_f = 6$ extends to these quivers. Dualities relate them to various generalized quivers which include E_6 SCFT as building blocks. Again, we identify families of such generalized quivers as different dual descriptions of a single theory $\mathcal{T}_{(f_1, f_3), g}[A_2]$, associated to a Riemann surface $C_{(f_1, f_3), g}$ with two types of punctures. We will identify the theory with a twisted compactification of the A_2 $(2, 0)$ six-dimensional CFT on $C_{(f_1, f_3), g}$, in the presence of appropriate defect operators. The Seiberg-Witten curve for the theory is a ramified triple cover of $C_{(f_1, f_3), g}$.

In section 4 we will extend the construction to general superconformal linear quivers of unitary groups. Argyres-Seiberg-like dualities will produce a variety of “elementary” interacting SCFTs akin to the E_6 theory. We will identify families of generalized quivers $\mathcal{T}_{(f_a), g}[A_{N-1}]$ based on such CFTs, and the relation to A_{N-1} $(2, 0)$ six-dimensional CFT on a Riemann surface $C_{(f_a), g}$, with defects labeled by Young Tableaux with N boxes. The Seiberg-Witten curve for the theory is a ramified N -th cover of $C_{(f_a), g}$. We explore all possible very strongly coupled regions of the parameter space of linear quivers of unitary groups. A dual weakly coupled special unitary gauge group typically emerges in such regions, but we also find some cases where the new gauge group is symplectic. In particular, we find that superconformal linear quivers of unitary group with one or two terminal symplectic nodes also belong to the class $\mathcal{T}_{(f_a), g}[A_{N-1}]$. The A_3 case includes a second classical example of Argyres-Seiberg duality, relating a $N_f = 6$ $USp(4)$ gauge theory and the E_7 SCFT.

In section 5 we will sketch some possible generalization of our result. Each section includes an introduction which does not require familiarity with Seiberg-Witten curve technology.

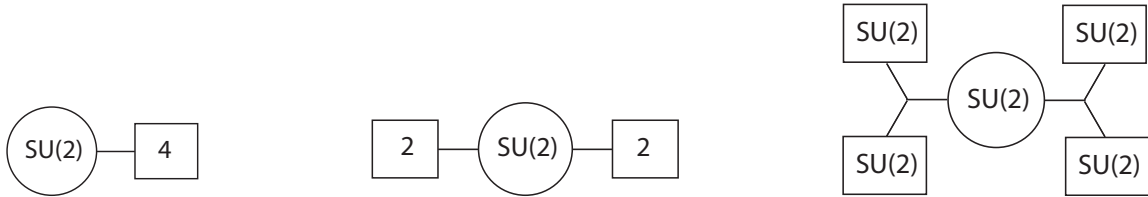

Figure 2: Different useful ways to depict $SU(2)$ gauge theory with four fundamental flavors. On the left, a standard quiver diagram, where circles indicate gauge groups, and squares fundamental flavors; the four flavors have an $SO(8)$ flavor symmetry. In the middle, a quiver diagram where the four flavors have been split into two groups of two flavors; each group carries a $SO(4) = SU(2) \times SU(2)$ flavor symmetry. On the right, a generalized quiver diagram, depicting separately the two $SU(2)$ flavor groups for each pair of fundamentals

2. $SU(2)$ generalized quivers

2.1 S-duality

The $\mathcal{N} = 2$ $SU(2)$ gauge theory with four fundamental flavors ($N_f = 4$) is a canonical example of $\mathcal{N} = 2$ SCFT. The gauge coupling

$$\tau = \frac{\theta}{\pi} + \frac{8\pi i}{g^2} \quad (2.1)$$

is exactly marginal, because the number of flavors is twice the number of colors. The theory has an $SO(8)$ flavor symmetry. In general n hypermultiplets in a complex representation of the gauge group support an $SU(n)$ flavor symmetry group, which is enhanced to $SO(2n)$ for pseudoreal representations, and $Sp(2n)$ for real representations. The fundamental representation of $SU(2) \sim Sp(1)$ is pseudoreal. The fundamental hypermultiplets transform in a vector 8_v representation of the flavor symmetry group. The $\mathcal{N} = 2$ $SU(2)$ gauge theory with $N_f = 4$ was solved in [1]. The theory enjoys an interesting S-duality group $SL(2, Z)$, which acts by the standard fractional linear transformations on τ and simultaneously acts on the flavor group $SO(8)$ by triality. The three eight dimensional representations of $SO(8)$ are permuted the same way as $SL(2, Z)$ permutes the three even spin structures on the torus.

It is useful to follow the action of triality on a certain subgroup of $SO(8)$. Let us split the four fundamental hypermultiplets into two pairs, each with a $SO(4)$ flavor symmetry. We denote one $SO(4)$ as $SU(2)_a \times SU(2)_b$ and the other as $SU(2)_c \times SU(2)_d$. To keep track of the four special $SU(2)$ subgroups of the flavor group, we will denote the $SU(2)$ theory with four flavors as in Fig. 2. An interesting feature of this subgroup is that while $8_v = (2_a \otimes 2_b) \oplus (2_c \otimes 2_d)$, the spinorial representations decompose as $8_s = (2_a \otimes 2_c) \oplus (2_b \otimes 2_d)$ and $8_c = (2_a \otimes 2_d) \oplus (2_b \otimes 2_c)$. Hence triality and S-duality permute all possible ways the four flavor symmetry subgroups $SU(2)_a \times SU(2)_b \times SU(2)_c \times SU(2)_d$ as in Fig. 3.

The theory has four mass deformations, which can be presented as an element of the Cartan subalgebra of the $SO(8)$ flavor symmetry. Again, it is useful to restrict our attention to the $SU(2)_a \times SU(2)_b \times SU(2)_c \times SU(2)_d$ subgroup of $SO(8)$, and label the masses

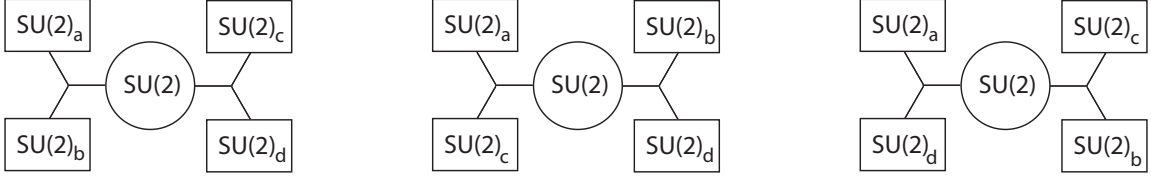

Figure 3: The action of S duality on the four $SU(2)$ flavor subgroups: the three possible ways to pair them up into the $SO(4)$ symmetry of two fundamentals

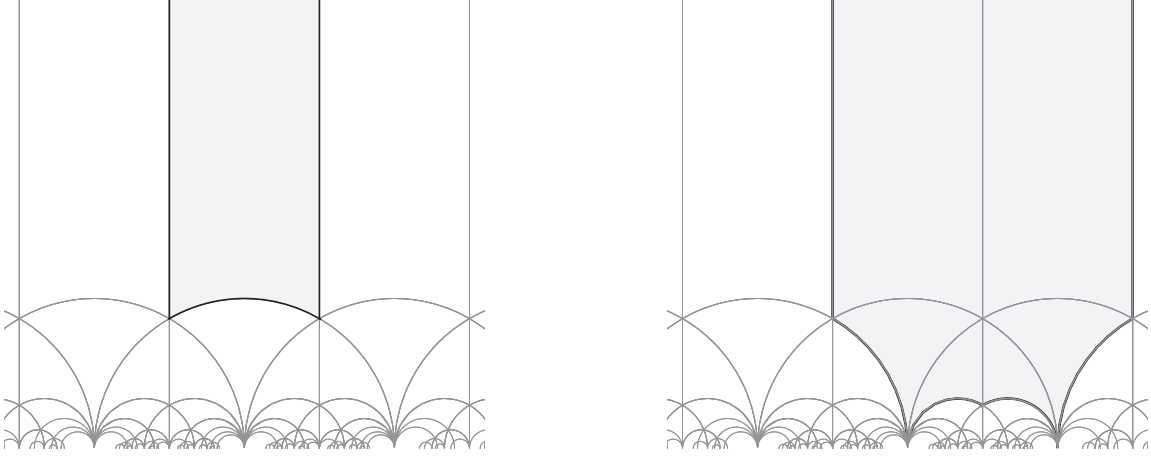

Figure 4: Left: (a) the space of gauge couplings τ modulo S-duality. Right: (b) the space of gauge couplings τ modulo S-duality transformations which do not permute the masses. At the three cusps $\tau = i\infty$, $\tau = 0$, $\tau = 1$ respectively, the weakly coupled description of the theory has flavor groups labeled as in fig. 3

accordingly as $m_{a,b,c,d}$. In particular, if we weakly gauge $SU(2)_a$, then m_a^2 will coincide with the expectation value of the corresponding vector multiplet scalar $u_a = \text{Tr}\Phi_a^2$. The action of triality on these mass parameters is particularly simple, as they are permuted along with the corresponding $SU(2)$ subgroups of $SO(8)$.

We want to anticipate an amusing point of view on this action, which will be explained in better detail in the next subsection. The parameter space of gauge couplings modulo S-duality $H/SL(2, Z)$ depicted in fig.4(a) coincides with the complex structure moduli space of a sphere with four equivalent punctures. If we only quotient by the subgroup of S-duality $\Gamma(2)$ which does not permute the mass parameters we obtain an extended moduli space depicted in fig.4(b), which coincides with the complex structure moduli space of a sphere with four marked punctures, labeled as a, b, c, d . The three cusps at $\tau = \infty, 0, 1$ map to the three possible degeneration limits of the sphere, where a, b , a, c or a, d collide (see fig. 5). These are the three weak coupling limits in fig. 3. The full S-duality group permutes the punctures among themselves the same way as it permutes the mass parameters $m_{a,b,c,d}$ and the $SU(2)_{a,b,c,d}$ subgroups.

Now we want to understand how much of this extends to more general superconformal

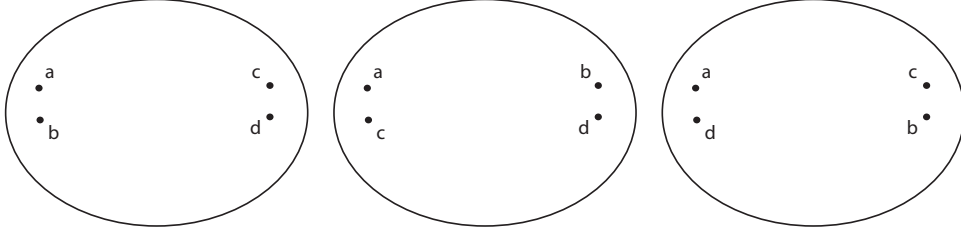

Figure 5: The degeneration limits of a sphere with four marked punctures. They correspond to the three weak coupling limits of $SU(2)$ $N_f = 4$ depicted in fig 3

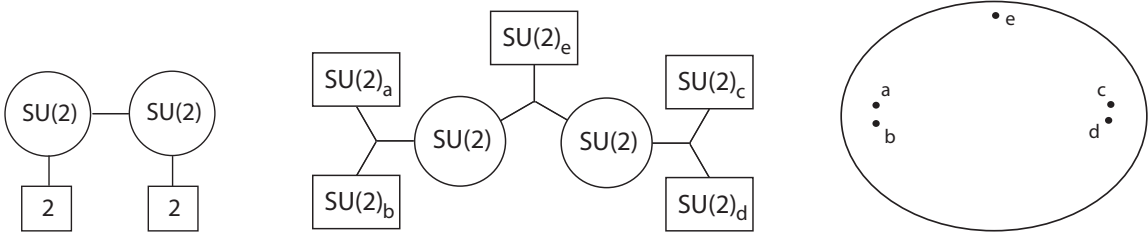

Figure 6: On the left, a standard depiction of an $SU(2)$ quiver with two $SU(2)$ gauge nodes, and two fundamental flavors at each node. In the middle, the same theory depicted as a generalized quiver, with the $SU(2)$ factors of the flavor group made evident and labeled. The space of gauge couplings is parameterized by a sphere with five marked punctures. At the cusps where two pairs of punctures collide, there is an S-dual frame where the quiver gauge theory is weakly coupled. On the right, we depict the correspondence between the labeling of punctures near the cusp, and the labeling of flavor groups of the corresponding weakly coupled quiver.

theories built out of $SU(2)$ gauge groups. Our first example is a two-node quiver. The gauge group is $SU(2)_1 \times SU(2)_2$, the matter consists of two fundamentals of $SU(2)_1$, one bifundamental in $2_1 \otimes 2_2$ and two fundamentals of $SU(2)_2$. Each gauge group is coupled to exactly 4 flavors, hence the two gauge couplings $\tau_{1,2}$ are exactly marginal and the quiver describes a SCFT. S-duality properties of this quiver were first analyzed in [8]. The overall flavor symmetry of this simple quiver is quite surprising: it is the product of five factors $SU(2)_a \times SU(2)_b \times SU(2)_c \times SU(2)_d \times SU(2)_e$. Two $SU(2)$ factors, say a, b , come from the $SO(4)$ flavor symmetry of the 2 fundamentals at the first node of the quiver. Two $SU(2)$ factors, say c, d from the $SO(4)$ flavor symmetry of the 2 fundamentals at the second node of the quiver. Finally, the flavor symmetry of the bifundamental hypermultiplet is $Sp(1) \sim SU(2)_e$, as the bifundamental representation $2_1 \otimes 2_2$ is real. See Fig. 6

There is a simple strategy to analyze the duality properties of this quiver: explore regions of the moduli space where one gauge group is extremely weakly coupled, and vary the coupling for the other gauge group. If we completely turn off the gauge coupling at the second node, the first gauge theory coincides with the $SU(2)$ gauge theory with four flavors, which sit in a $(2_a \otimes 2_b) \oplus (2_e \otimes 2_2)$ representation (2_2 denotes the fundamental representation of the second gauge group). If we keep the second gauge coupling arbitrarily weak, we expect S-duality to be still valid for the first gauge group. If we start from the

weakly coupled quiver theory and drive the first gauge coupling to some other cusp in the upper half plane, we should use a different S-dual description for the first node, and ask what is the matter content of the resulting $SU(2) \times SU(2)$ weakly coupled gauge theory.

Because of the action of triality, the first gauge group may now be coupled to fundamental hypermultiplets in a $(2_a \otimes 2_e) \oplus (2_b \otimes 2_2)$ or $(2_e \otimes 2_b) \oplus (2_a \otimes 2_2)$ representation. In either case we see a bifundamental representation for the two gauge groups, hence our tentative S-duality has brought the quiver gauge theory back to itself. In the process, the three flavor groups $SU(2)_a \times SU(2)_b \times SU(2)_e$ have been permuted among each other. For example, $SU(2)_a$ or $SU(2)_b$ may be the flavor symmetry of the new bifundamental fields. Now that the gauge coupling of the first gauge group is arbitrarily weak, albeit in a new S-dual frame, we should be able to repeat the exercise on the second node. We could keep the first gauge coupling fixed at this S-dual weak coupling region, and increase the second gauge coupling, until it undergoes S-duality to a different weakly coupled description. The four flavor symmetries of the $SU(2)$ $N_f = 4$ theory at the second node are, say, $SU(2)_a \times SU(2)_1 \times SU(2)_c \times SU(2)_d$. In the new S-dual frame, the three $SU(2)_a \times SU(2)_c \times SU(2)_d$ flavor groups will be permuted.

We see that the S-dualities of single nodes of the quiver have been inherited by the full quiver theory. Although this is not a surprise per se, the action of S-dualities on the flavor symmetry group shows a surprising feature: the two $SL(2, Z)$ S-duality groups do not commute! They must be subgroups of a full S-duality group which acts on the flavor symmetry groups as the permutation group of five objects. Our analysis only explored the boundary of the gauge coupling moduli space. A full analysis based on the Seiberg-Witten curve is given in the next subsection.

Again, we find it useful to anticipate a few results. Our simple reasoning captured all the weakly coupled cusps of the moduli space. At all cusps the theory is described by the two-node quiver gauge theory, and the five flavor symmetry groups appear in all possible combinations. The gauge coupling parameter space modulo S-dualities coincides with the complex structure moduli space of a sphere with five punctures. If we only quotient by S-dualities which do not permute the mass parameters $m_{a,b,c,d,e}$ and flavor symmetry groups $SU(2)_{a,b,c,d,e}$, then we should consider instead the moduli space of a sphere with five marked punctures, labeled by a, b, c, d, e . The weakly coupled cusps of moduli space correspond to the degeneration limits where punctures collide in different possible ways. See fig. 6 for an example.

Next, we consider a superconformal linear quiver of three $SU(2)$ gauge groups, with two fundamental flavors at each end node, so that all nodes have $N_f = 4$. A novel phenomenon will become apparent. We will denote the gauge groups as $SU(2)_1 \times SU(2)_2 \times SU(2)_3$. The reader may guess already the form of the flavor symmetry group: six $SU(2)$ factors, $SU(2)_{a,b}$ from the first two fundamental hypers, $SU(2)_c$ and $SU(2)_d$ from the two sets of bifundamental hypers and $SU(2)_{e,f}$ from the fundamental hypers at the last node. See Fig. 7

If the middle node is very weakly coupled, we expect the S-duality at the side nodes to survive, and permute freely the roles of $SU(2)_{a,b,c}$ or of $SU(2)_{d,e,f}$. If we take both end nodes to be very weakly coupled, we may also want to apply S-duality on the middle

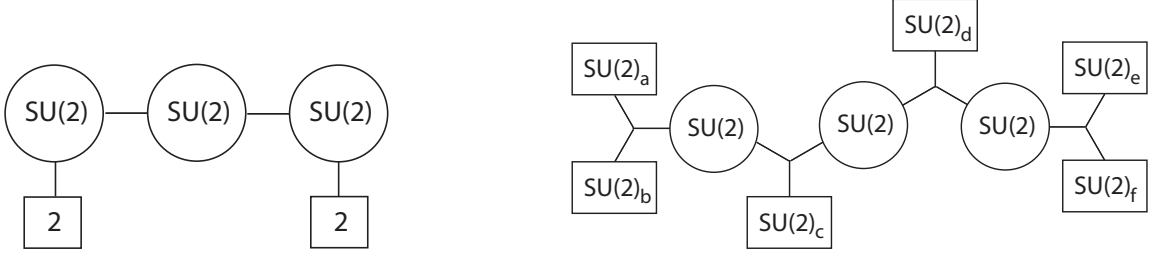

Figure 7: On the left, a standard depiction of an $SU(2)$ quiver with three $SU(2)$ gauge nodes, and two fundamental flavors at each terminal node. On the right, the same theory depicted as a generalized quiver, with the $SU(2)$ factors of the flavor group made evident and labeled.

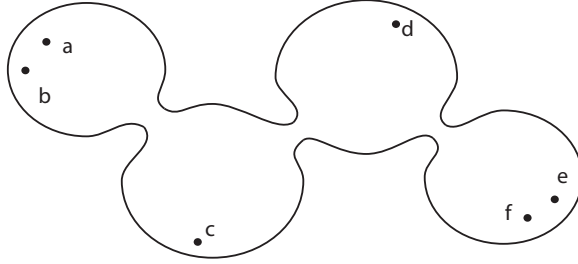

Figure 8: The space of gauge couplings for the theory in fig. 7 is parameterized by a sphere with six punctures. The six punctures can collide in two distinct ways. On the right, we depict the type of degeneration which corresponds to the weak coupling limit for the quiver. Notice the relation between labeling of punctures and of $SU(2)$ flavor groups.

node. The matter fields at that node sit in a $2_2 \otimes [(2_1 \otimes 2_c) \oplus (2_3 \otimes 2_d)]$ representation, where each summand is a bifundamental hypermultiplet. If we apply S-duality, the new matter fields will either be in $2_2 \otimes [(2_1 \otimes 2_d) \oplus (2_3 \otimes 2_c)]$ or in $2_2 \otimes [(2_1 \otimes 2_3) \oplus (2_c \otimes 2_d)]$. The first possibility gives us back the original three nodes linear quiver. The main effect of this S-duality operation is to permute the flavor symmetries of the two bifundamentals. Together with S-duality at the other nodes, this is enough to generate the full permutation group of the six gauge groups.

The second possibility is the real surprise. In that duality frame, the theory is not a standard quiver anymore, but it is the first example of a “generalized $SU(2)$ quiver”. The gauge group is still $SU(2)_1 \times SU(2)_2 \times SU(2)_3$. Each of the gauge groups now is coupled to two fundamentals, with flavor symmetries $(2_a \otimes 2_b)$, $(2_c \otimes 2_d)$, $(2_e \otimes 2_f)$ respectively. Furthermore, they couple simultaneously to four hypermultiplets which carry an overall $2_1 \times 2_2 \times 2_3$ representation of the gauge groups, and no flavor symmetry 9. This object can be seen as a bifundamental hypermultiplet of two of the gauge groups, whose $SU(2)$ flavor symmetry has been further gauged.

This exhausts the set of weakly coupled duality frames which can be reached by the elementary S-duality at each node. Any further S-duality transformation would bring us back to the original linear quiver with some rearrangement of the flavor symmetry groups.

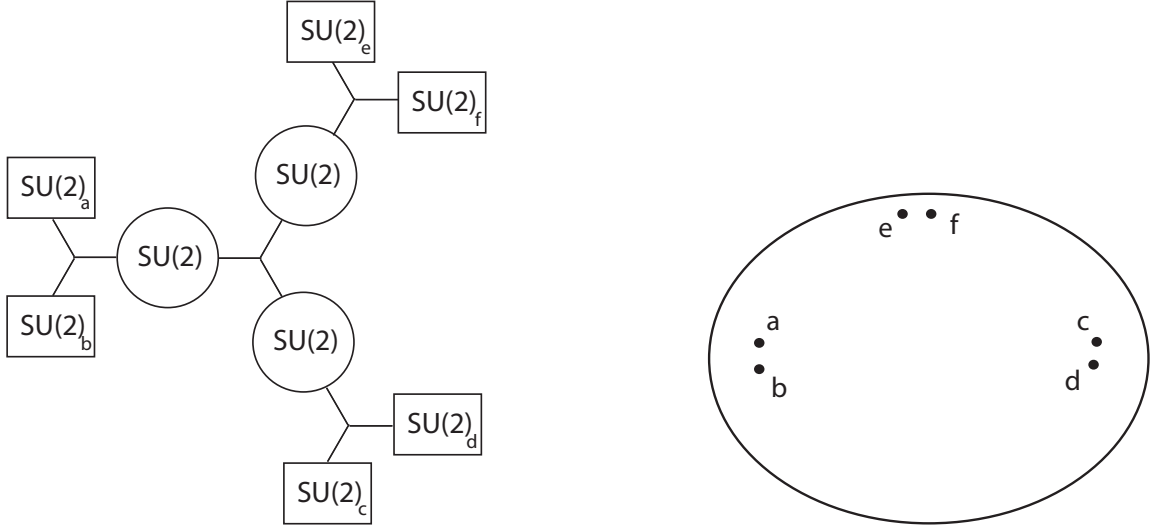

Figure 9: From left to right. The result of S-duality at the middle node of the three-node quiver: a generalized quiver where three $SU(2)$ gauge groups are coupled independently to the same group of four hypermultiplets. The region in gauge coupling parameter space corresponding to this quiver and this labeling of flavor groups.

We will show in the next subsection that this also exhausts the list of possible cusps of the gauge coupling parameter space. The exact gauge coupling parameter space coincides with the moduli space of a sphere with six marked points. There are two types of degeneration limits, depicted in figures 7 and 9. They correspond to the two distinct realizations of the theory as a weakly coupled generalized quiver.

Finally we can consider a linear superconformal quiver theory with n $SU(2)$ nodes. There will be $n + 3$ $SU(2)$ flavor groups. As before we expect that if all nodes but one are very weakly coupled, S-duality at that node remains a valid symmetry of the theory. Repeated action of S-duality at different nodes can rearrange the matter content profoundly. The result will be a variety of generalized quivers, where some blocks of four hypermultiplets play the role of two fundamentals for a single $SU(2)$ gauge group, some play the role of a bifundamental for two $SU(2)$ gauge groups, and the others are coupled simultaneously to three $SU(2)$ gauge groups. In each duality frame there will always be n $SU(2)$ gauge groups, each with $N_f = 4$. There are always $n + 1$ sets of four hypermultiplets. Finally, there must be $n + 3$ flavor symmetry groups. What is the set of possible topologies for such generalized quivers? It will be convenient to represent each generalized quiver as a graph, with a trivalent vertex for each hypermultiplet, an internal edge for each gauge group, and an external edge for each flavor group. The number of loops of such a graph is the number of internal edges minus the number of nodes plus one, i.e. 0. See Fig 10 S-duality at any edge rearranges the other four edges attached to its endpoints. Under the action of S-duality, the graph will always remain a (binary) tree, and it is easy to argue that every possible topology for that tree can be reached by elementary S-duality moves. Hence we are lead to postulate the existence of a global $\mathcal{N} = 2$ superconformal theory,

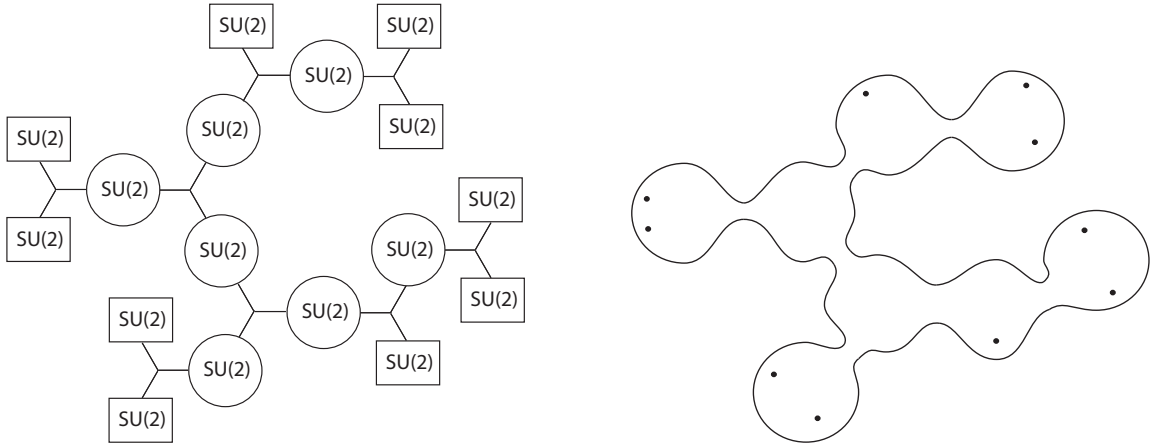

Figure 10: A generalized quiver with no loops. The space of gauge couplings is parameterized by a sphere with 10 punctures. The quiver is weakly coupled at the cusp where the punctured sphere degenerates as in figure. Punctures correspond to flavor $SU(2)$ groups. Long/thin necks correspond to weakly coupled $SU(2)$ gauge groups.

denoted as $\mathcal{T}_{n+3,0}[A_1]$, with an intricate n dimensional parameter space of gauge couplings with several weak coupling cusps, labeled by all the possible loopless generalized quivers of n $SU(2)$ gauge groups.

The moduli space should have boundaries where a single $SU(2)$ gauge group becomes infinitely weak. As the generalized quiver is a tree, decoupling a gauge group leads to two disconnected quivers. The theory becomes the sum of two decoupled theories, which are $\mathcal{T}_{m+3,0}[A_1]$ and $\mathcal{T}_{n-m+2,0}[A_1]$ for some m (see fig. 11). In the next subsection we will confirm this picture, by computing the Seiberg-Witten curve and differential for the linear quiver gauge theories. The parameter space of gauge couplings turn out to coincide with the moduli space of $n + 3$ points on the sphere $\mathcal{M}_{n+3,0}$. The various weakly coupled S-dual frames of the theory coincide with the different ways a sphere with $n + 3$ points can degenerate completely to a set of $n + 1$ three-punctured spheres attached together at n nodes to form a generic binary tree. The S-duality group is the fundamental group π_1 of $\mathcal{M}_{n+3,0}$. The action of S-duality on the $n + 3$ flavor symmetry groups is a permutation action, and coincides with the permutation action on the $n + 3$ punctures on the sphere.

There is no reason to limit ourselves to generalized quivers with the topology of a tree. In general we can build a generalized quiver with n flavor groups and g loops by connecting $n + 2g - 2$ sets of four hypers with $n + 3g - 3$ gauge groups. Elementary S-dualities at single nodes connect all the generalized quivers with the same g and n into a single theory which we will label as $\mathcal{T}_{n,g}[A_1]$. See Fig 12 and 13,14

We can make gauge couplings infinitely weak to either open up a loop, or disconnect the generalized quiver into two subquivers. We do not have a direct brane construction of the SW curve for these generalized quiver gauge theories. We will conjecture an answer which satisfy several consistency checks. There is an evident similarity between the weak coupling limits of a generalized quiver and the and the degeneration limits of a Riemann

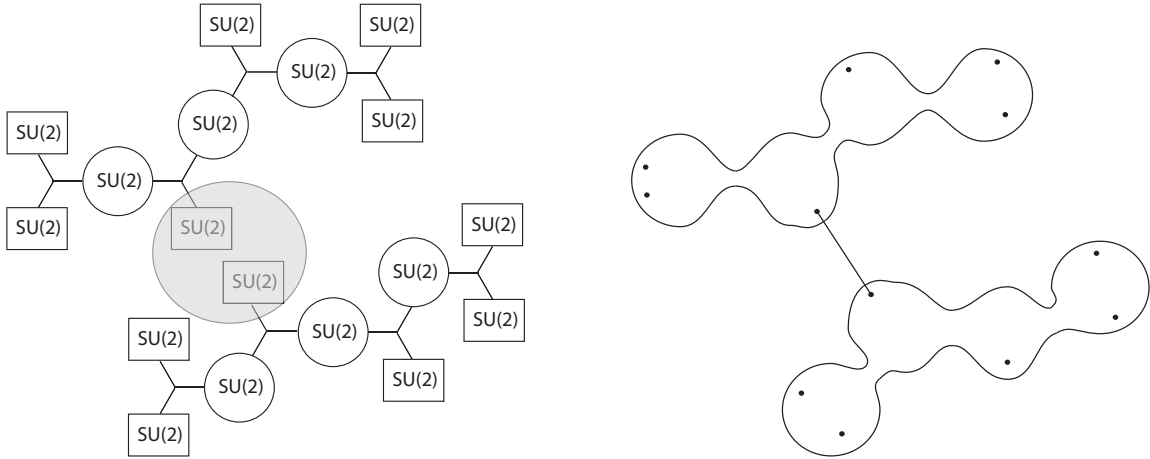

Figure 11: As one gauge coupling is brought to zero, the $SU(2)$ gauge theory decouples and leaves behind two $SU(2)$ flavor groups. This corresponds to the full degeneration limit of the punctured sphere, which leaves behind two punctured spheres

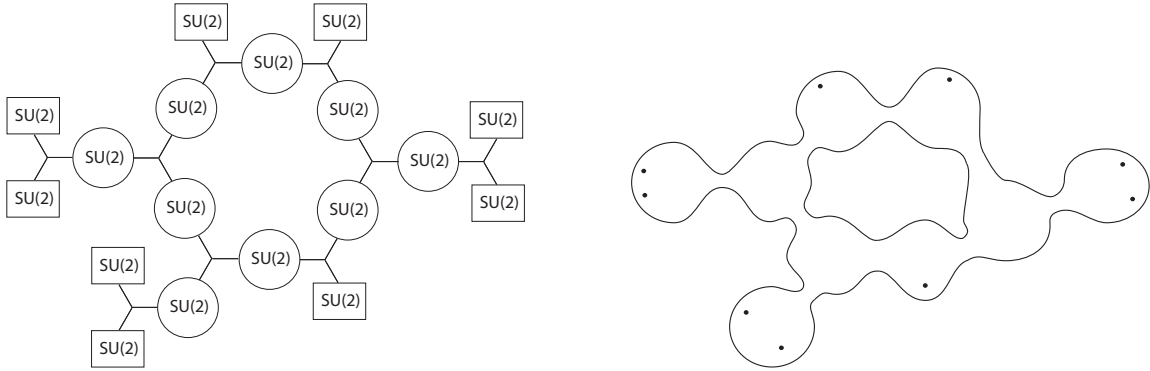

Figure 12: A generalized quiver with one loop. The space of gauge couplings is parameterized by a torus with 9 punctures. The quiver is weakly coupled at the cusp where the punctured sphere degenerates as in figure.

surface of genus g and n punctures. Indeed the weak coupling S-dual frames we can identify from S-duality at each node of the generalized quivers in $\mathcal{T}_{n,g}[A_1]$ precisely coincide to the different ways a punctured Riemann surface can degenerate to a set of $n + 2g - 2$ three-punctured spheres joined by $n + 3g - 3$ thin tubes. We are lead to conjecture that the parameter space of gauge couplings of $\mathcal{T}_{n,g}$ coincides with the Teichmuller moduli space of a genus g Riemann surface with n punctures $\tilde{\mathcal{M}}_{n,g}$, reduced by S-dualities to the moduli space $\mathcal{M}_{n,g}$

In the next subsection we will conjecture a Seiberg-Witten curve and differential for these theories $\mathcal{T}_{g,n}[A_1]$, which has $\mathcal{M}_{n,g}$ as the moduli space of exactly marginal deformations. The SW curve is a ramified double cover of the genus g Riemann surface $C_{g,n}$. The SW differential has poles at the preimage of the n punctures on $C_{g,n}$. At the boundaries of $\mathcal{M}_{n,g}$, $C_{g,n}$ degenerates either to a curve of lower genus $C_{g-1,n+2}$ or to the union of two

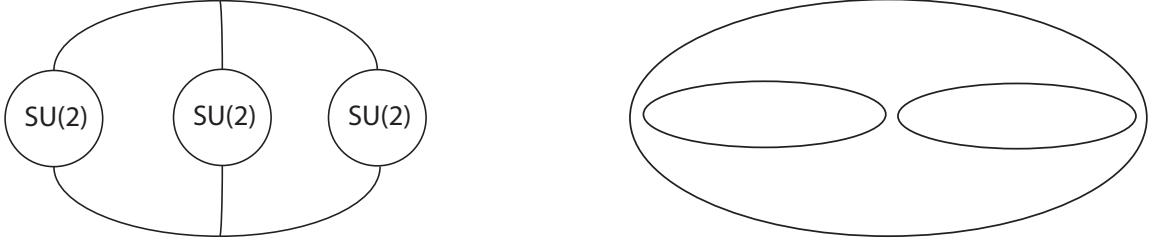

Figure 13: A generalized quiver with two loops and no flavor groups, in the first of two distinct S-duality frames. The gauge couplings are parameterized by a genus two Riemann surface. We depict the degeneration limit of the genus two Riemann surface which map to the weak coupling limit for the generalized quiver.

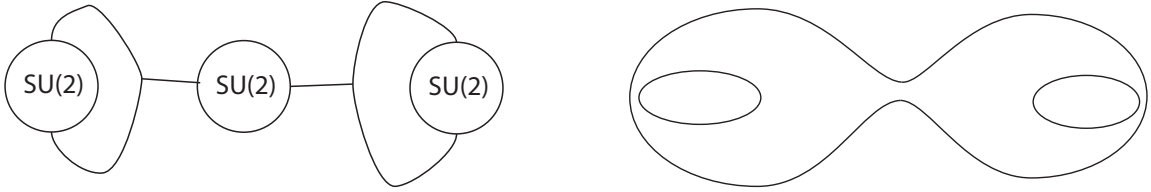

Figure 14: A generalized quiver with two loops and no flavor groups, in the second of two distinct S-duality frames. The gauge couplings are parameterized by a genus two Riemann surface. We depict the degeneration limit of the genus two Riemann surface which map to the weak coupling limit for the generalized quiver.



Figure 15: The first of two decoupling limits of a generalized quiver with two loops and no flavor groups, and the corresponding complete degeneration of a genus two Riemann surface

curves $C_{g',n'+1} \cup C_{g-g',n-n'+1}$ (see fig. 15, 16). The SW curve similarly degenerates to the curve for the theory $\mathcal{T}_{g-1,n+2}[A_1]$ or $\mathcal{T}_{g',n'+1}[A_1] \times \mathcal{T}_{g-g',n-n'+1}[A_1]$ exactly in the way associated with the decoupling limit of an $SU(2)$ gauge group. In the last subsection we will present a direct definition of the theory $\mathcal{T}_{n,g}$ as the (twisted) compactification of the $A_1(2,0)$ theory on a Riemann surface of genus g , in the presence of n codimension 2 defect operators. This will give a direct construction of the conjectured SW curve.

2.2 SW curves

The Seiberg-Witten curve for linear quivers of unitary gauge groups, possibly with fundamental matter at one end, has been computed in section 2 of [6]. We will simply take the final result, specialized to a product of n $SU(2)$ gauge groups with two hypermultiplets at each end. The curve is given as a polynomial equation in two variables (v, t) , defined in



Figure 16: The second of two decoupling limits of a generalized quiver with two loops and no flavor groups, and the corresponding complete degeneration of a genus two Riemann surface

$\mathbb{C} \times (\mathbb{C}^* - \{t_0, \dots, t_n\})$. The polynomial is of second order in v and order $n + 1$ in t . If we collect the same powers of t it can be written as

$$v^2 t^{n+1} + c_1(v^2 - u_1)t^n + \dots + c_n(v^2 - u_n)t + c_{n+1}v^2 = 0 \quad (2.2)$$

At weak coupling, the coefficient of each power of t is associated with a gauge group in the quiver. The degree in v of each coefficient is two because all gauge groups are $SU(2)$. The u_i coefficients parameterize the Coulomb branch of the theory. At weak coupling, u_i should be identified with the expectation value $Tr\Phi_i^2$ for the i -th $SU(2)$ gauge group in the quiver. The c_i parameterize the space of gauge couplings of the theory. More precisely, if we collect the same powers of v as (in general the subscript of a polynomial will denote its degree)

$$\prod_{a=0}^n (t - t_a)v^2 = U_{n-1}(t)t \quad (2.3)$$

then at weak coupling

$$\tau_a = \frac{1}{i\pi} \log \frac{t_{a-1}}{t_a}. \quad (2.4)$$

The overall scale of t_a is immaterial. We can set, for example, $t_0 = 1$.

The Seiberg Witten differential is not written down explicitly in [6], but it is implicit in the analysis of the low energy effective action and BPS states. See [9] for a detailed discussion. It has a very simple expression, which is valid for all the SW curves described in [6].

$$\lambda = v \frac{dt}{t} \quad (2.5)$$

Indeed the embedding space has a natural complex two form $dv \frac{dt}{t}$, and if a curve is defined by a polynomial equation $F(v, t) = 0$, then

$$\frac{\partial \lambda}{\partial u_i} = - \frac{\partial F}{\partial u_i} \frac{dt}{t} \frac{\partial F}{\partial v} \quad (2.6)$$

gives a basis of holomorphic differentials whenever u_i is a normalizable deformation. In general the normalizable deformations are the coefficient of a monomial in F whose degree in v is smaller than the degree of F minus 1, and whose degree in t is positive and smaller than the degree of F . We can easily see from 2.2 that the u_a are the only marginal deformations.

Let us specialize further to the case $n = 1$, to recover the SW curve for $SU(2)$ $N_f = 4$. We warn the reader that we do not plan to bring it to a more traditional form, but quite the opposite. The curve equation is

$$(t - 1)(t - t_1)v^2 = ut \quad (2.7)$$

The central charges are the period integrals of

$$\lambda = \frac{\sqrt{u}}{\sqrt{t(t-1)(t-t_1)}} dt \quad (2.8)$$

on appropriate cycles of the SW curve. The trivial u dependence is a consequence of conformal invariance. The gauge coupling τ is traditionally identified with the modular parameter of an auxiliary torus of equation.

$$y^2 = t(t-1)(t-t_1) \quad (2.9)$$

There still is a certain amount of redundancy in the parameterization of the gauge coupling by t_1 . The torus degenerates when $t_1 \rightarrow \infty$, $t_1 \rightarrow 1$, $t_1 \rightarrow 0$. The first degeneration is the naive weak coupling limit for the $SU(2)$ gauge theory at $\tau \rightarrow i\infty$, the other two correspond to the S-dual weakly coupled regions $\tau \rightarrow 1, 0$ respectively. It is useful to modify our coordinate system slightly, to make the action of S-duality more manifest. If we write simply $v = tx$, so that $\lambda = xdt$, the curve becomes

$$t(t-1)(t-t_1)x^2 = u \quad (2.10)$$

S-duality acts by fractional linear transformations, generated by $(t, x) \rightarrow (1-t, x)$ and $(t, x) \rightarrow (1/t, -t^2x)$. The S-duality invariant moduli space is simply the complex structure moduli space of a sphere with four punctures, at $0, 1, t_1, \infty$.

The four punctures can be put on an even footing by a further fractional linear transformation $t \rightarrow \frac{az+b}{cz+d}$, $x \rightarrow (cz+d)^2x$ to a final

$$x^2 = \frac{u}{\Delta_4(z)} \quad (2.11)$$

Then t_1 is the cross-ratio of the four roots of $\Delta_4(z)$. The SW differential is $\lambda = xdz$. Here we consider z as a variable on a four-punctured sphere, and x is naturally a coordinate on the cotangent bundle of the sphere. We see here the first example of a certain canonical form for the SW curve, which we will meet over and over in the paper. For generalized $SU(2)$ quivers the canonical form is

$$x^2 = \phi_2(z) \quad (2.12)$$

(x, z) are local coordinates in the cotangent bundle of some punctured Riemann surface. The SW differential is the canonical one form $x dz$. The expression $\phi_2(z) dz^2$ is a quadratic differential on the punctured Riemann surface with appropriate poles at the puncture.

For $SU(2)$ $N_f = 4$ the differential $\phi_2 dz^2$ on the four-punctured sphere has simple poles at all punctures. The gauge coupling moduli space can be identified with the moduli space

of a four punctured sphere $\mathcal{M}_{4,0}$, or better with the Teichmuller moduli space $\tilde{\mathcal{M}}_{4,0}$ subject to the action of the S-duality group the fundamental group $\pi_1(\mathcal{M}_{4,0})$.

In the present situation, with no mass deformations, the parameter τ coincides with the gauge coupling of the IR $U(1)$ gauge theory, but that will not be true in presence of mass deformations. The parameter τ should be really considered a convenient parametrization of the exactly marginal deformations of the theory. It does not really coincide with the UV gauge coupling, at least in standard renormalization schemes (see for example [10]), except asymptotically at weak coupling. The Teichmuller space $\tilde{\mathcal{M}}_{4,0}$ is known to coincide with the upper half plane, i.e. the moduli space of a two-torus defined by the auxiliary equation 2.9. Hence τ is really nothing else but a coordinate on the Teichmuller space $\tilde{\mathcal{M}}_{4,0}$. This distinction is important when we study general linear quivers, where this fortuitous coincidence between the ambiguously-defined space of “UV gauge couplings” and the true gauge coupling parameter space visible from the SW curve does not happen.

If we go back to the general n case 2.3, and we apply the same coordinate transformation as for $n = 1$, the symmetry between the $n + 3$ punctures at $t = 0, \dots, t_a, \infty$ becomes manifest:

$$x^2 = \frac{U_{n-1}(z)}{\Delta_{n+3}(z)} = \phi_2(z) \quad (2.13)$$

The quadratic differential $\phi_2 dz^2$ has simple poles at all punctures. The parameter space of gauge couplings is parameterized by the cross-ratios of the roots of $\Delta_{n+3}(z)$, and coincides with the moduli space of a $n + 3$ punctured sphere $\mathcal{M}_{n+3,0}$. The S-duality group of the theory is the fundamental group $\pi_1(\mathcal{M}_{n+3,0})$

To see the action of S-duality on the flavor symmetry groups, we need to introduce some mass deformations. The mass deformed curve for the general quiver is also computed in [6]. We collect immediately the same powers of v

$$\prod_{a=0}^n (t - t_a) v^2 = M_{n+1}(t) v + U_{n+1}(t) \quad (2.14)$$

All the $n + 2$ coefficients of M_{n+1} , the first and the last coefficients of U_{n+1} are mass parameters. Because of the freedom $v \rightarrow v + v_0$ only $n + 3$ parameters are physical. The Seiberg-Witten differential has now simple poles, at $t = 0, t = t_a, t = \infty$. Near $t = t_a$ one of the roots $v_{\pm}(t)$ diverges as

$$\lambda = v \frac{dt}{t} \sim \frac{M_{n+1}(t_a)}{t_a \prod_{b=0}^{n'} (t_a - t_b)} \frac{dt}{t - t_a} \quad (2.15)$$

At $t = 0$ there is a pole for both roots of v

$$\lambda = v \frac{dt}{t} \sim v_{\pm}(0) \frac{dt}{t} \quad (2.16)$$

and similarly at $t \rightarrow \infty$. In the brane setup of [6] the full flavor symmetry for $SU(2)$ gauge groups is not visible. The manifest flavor symmetry for bifundamentals is the naive $U(1) \in SU(2)$, and for the fundamentals is $U(2) \in SO(4)$.

The residues at t_a have been identified with the $U(1)$ mass parameters for the a -th set of bifundamentals ($a = 0$ and $a = n$ are the fundamentals, and the $U(1)$ is the diagonal subgroup of $U(2)$). All these $U(1)$ are the Cartans of appropriate $SU(2)$ true flavor symmetry groups. Furthermore the difference between the asymptotic values $v_{\pm}(0)$ is identified with the mass parameter for the Cartan of the $SU(2)$ subgroup in the $U(2)$ flavor symmetry at the first node. Similarly the difference between the asymptotic values $v_{\pm}(\infty)$ is identified the mass parameter for the Cartan of the $SU(2)$ subgroup in the $U(2)$ flavor symmetry at the last node. We see that each puncture in the t plane, be it $t = 0, \dots, t_a, \dots, \infty$ is associated to the mass parameter of a specific $SU(2)$ flavor symmetry group, but in the variables v, t , the identification is still unpleasantly asymmetric.

Things become a bit more transparent after a change of coordinates. First of all, we should shift away the linear term in v to get

$$\prod_{a=0}^n (t - t_a)^2 v^2 = U_{n+1}(t) \prod_{a=0}^n (t - t_a) - \frac{1}{4} M_{n+1}(t)^2 \quad (2.17)$$

After the shift in v the Seiberg-Witten differential takes a form $\lambda = v \frac{dt}{t} - \frac{M}{t\Delta} dt$. We now modify the differential, and bring it back to $\lambda = v \frac{dt}{t}$. This modification is harmless: the residues of $\frac{M}{t\Delta} dt$ are linear combinations of the mass parameters of the theory, and the the first derivatives λ_{u_i} are unchanged, and still coincide with the holomorphic one forms on the SW curve. The central charges are shifted by a certain linear combination of the mass parameters. This amounts to a shift of the flavor charges of BPS particles by multiples of their gauge charges, i.e. to a redefinition of the flavor currents.

Notice that if the flavor symmetries are nonabelian, the charges of the BPS particles in the spectrum under the Cartan subalgebra of the flavour group must be the weights of the appropriate irreps of the flavor group. In the original brane setup only the $U(1)$ Cartan was visible for $n + 1$ of the $SU(2)$ flavor groups, and the original SW differential gave an assignment of flavor charges which was possibly incompatible with the full non-abelian flavor symmetry. Inspection of a few examples shows that the shift of the SW differential automatically cures that unpleasantness. Now at each of the $n + 3$ punctures in the t plane λ has poles on both branches $v_{\pm}(t) \frac{dt}{t}$, with equal and opposite residue given by the mass parameter of the corresponding $SU(2)$ flavor symmetry group.

Finally we can do our usual transformation to coordinates (x, z) , to bring the punctures on the same footing. The final result is

$$x^2 = \frac{P_{2n+2}(z)}{\Delta_{n+3}(z)^2} = \phi_2(z) \quad (2.18)$$

The mass parameters m_a^2 of the $SU(2)$ flavor symmetry groups are the coefficients of the double poles in the quadratic differential $\phi_2 dz^2$. In presence of mass deformations it is a bit arbitrary to define an origin for the u parameters. If we set an origin at $P_{2n+2} = P_{2n+2}^{(0)}$, we can write the deformation $P_{2n+2}(z) = P_{2n+2}^{(0)}(z) + \Delta_{n+3}(z) U_{n-1}(z)$ which does not change the coefficients of the double poles. The n coefficients of $U_{n-1}(t)$ parameterize the Coulomb branch.

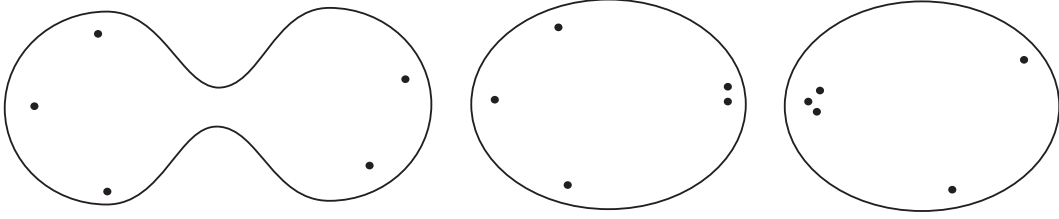

Figure 17: A degeneration limit of a five punctured sphere to a four punctured sphere and a three punctured sphere. Shown as the collapse of a thin tube. From the point of view of the first sphere, two punctures are collapsing to one. From the point of view of the second sphere, three punctures are collapsing to one

The punctures on the z plane are now associated to the factors of the flavor group. The moduli space of a sphere with $n + 3$ distinguished punctures $\mathcal{M}'_{n+3,0}$ is a cover of the gauge moduli space $\mathcal{M}_{n+3,0}$. The S-duality group $\pi_1(\mathcal{M}_{n+3,0})$ can be factored as the semi-direct product

$$0 \rightarrow \pi_1(\mathcal{M}'_{n+3,0}) \rightarrow \pi_1(\mathcal{M}_{n+3,0}) \rightarrow S \rightarrow 0 \quad (2.19)$$

The quotient S acts as the permutation group on the punctures, i.e. on factors of the flavor group.

It is important not to confuse the gauge coupling parameter space, i.e. the space of exactly marginal deformations of the $\mathcal{N} = 2$ SCFT, $\mathcal{M}_{n+3,0}$, with the space of possible IR gauge couplings, which are the period matrix of the SW curve. The complex structure of the SW curve is determined by the polynomial $P_{2n+2}(z)$, through the auxiliary equation

$$y^2 = P_{2n+2}(z) \quad (2.20)$$

and depends on everything, including u_a parameters and mass parameters. The space $\mathcal{M}_{n+3,0}$ is parameterized by the (cross-ratios of the) roots of $\Delta_{n+3}(z)$ only.

There is an important and simple consequence of the equivalence between different punctures in the z plane. If we go to the boundary component of moduli space where m punctures collide, we can always pick an S-duality frame where the punctures are $0, t_0, t_1, \dots, t_{m-2}$. Then the formula 2.4 tells us that the gauge coupling at the $m - 1$ -th node is becoming very weak, and the quiver is breaking down to two decoupled subquivers, just as the punctured sphere is degenerating to two sub-spheres joined by a nodal singularity (See figure 17 for a case with $n = 2$ and $m = 3$). It is easy to see how the process affects the SW curve. We can focus on one sub-sphere, scaling all $t_{0, \dots, m-2}$ uniformly to 0 by a factor of ϵ . We want to keep all masses finite in the degeneration process. The coefficients of double poles at t_a for $a \leq m - 2$ receive a factor $\epsilon^{-2(m-1)}$ from $\Delta_{n+3}(z)$. We should adjust $P_{2n+2}(z)$ so that it would scale as $\epsilon^{2(m-1)}$ at $t = t_a$, so that the coefficient of the double poles remain finite as $\epsilon \rightarrow 0$.

This implies that $P_{2n+2}(t) \rightarrow t^{2(m-1)} P_{2n-2m+4}(t)$ after the $\epsilon \rightarrow 0$ limit, and cancels enough factors of t in $\Delta_{n+3}(t) \rightarrow t^{2m} \Delta_{n-m+3}(z)$ to leave a second order pole in ϕ_2 at $t = 0$. Hence the SW curve reduces properly to the curve for the linear quiver of $n - m + 1$ nodes.

The coefficient of the new double pole at 0 is the mass parameter of the new flavor symmetry group left by the decoupling gauge group. It could have been read in the original sphere by integrating $\sqrt{\phi_2}$ around the m collapsing punctures. If we want to study the second fragment of the SW curve, we need to bring instead the other $n - m + 3$ punctures to infinity. The same path will compute the coefficient of the double pole at infinity, hence the mass parameters for the two new $SU(2)$ flavor groups in the two subquivers coincide. This was expected: the mass parameters are simply the u parameter of the decoupling gauge group.

We conclude that as one approaches boundaries of $\mathcal{M}_{n+3,0}$ where the sphere degenerates and splits, the theory $\mathcal{T}_{n+3,0}[A_1]$ also decouples to the product theory $\mathcal{T}_{m+1,0}[A_1] \times \mathcal{T}_{n-m+4,0}[A_1]$. If we let as many handles degenerate as possible, to go to a generic cusp in the parameter space $\mathcal{M}_{n+3,0}$ the sphere approaches a collection of three-punctured spheres connected into a binary tree. Weakly coupled $SU(2)$ gauge groups appear in the same pattern. The canonical SW curve corresponding to a three punctured sphere

$$x^2 = \frac{P_2(z)}{\Delta_3(z)^2} \quad (2.21)$$

is the SW curve of a block of four hypermultiplets. All coefficients in $P_2(z)$ are mass parameters for the three important $SU(2)$ flavor subgroups. Hence at the cusp of the parameter space, the theory $\mathcal{T}_{n+3,0}[A_1]$ takes the form of a weakly coupled generalized $SU(2)$ quiver. The shape of the quiver coincides with the shape of the binary tree of three punctured spheres.

Next we would like to conjecture a SW curve for generalized $SU(2)$ conformal quiver gauge theories with g loops, the $\mathcal{T}_{n,g}[A_1]$. Notice that [6] presents the solution for a close linear loop of unitary groups, with bifundamental hypermultiplets between consecutive nodes. The closed linear loop of n $SU(2)$ groups is the perfect starting point to study the genus one case, $\mathcal{T}_{n,1}[A_1]$. For zero masses, the SW equation for the closed loop of n $SU(2)$ gauge groups is given simply as curve in $\mathbb{C} \times \mathbb{T}^2$, which we parameterize with coordinates v and z . The curve is defined by a degree 2 polynomial in v

$$v^2 = f_2(z) \quad (2.22)$$

The function $f_2(z)$ is a meromorphic function on \mathbb{T}^2 , with simple poles at the n punctures $z = z_a$. The SW differential is again vdz .

The space of couplings of the theory is the moduli space of a torus with n marked points. In the weak coupling limit, the gauge couplings are simply given as $\tau_a \sim z_{a+1} - z_a$. The sum of gauge couplings is the modular parameter of the torus. The space of possible $f_2(z)$ is n dimensional: constant shifts are allowed, but the sum of the residues of f_2 is zero, because the torus is compact.

The solution with mass deformations given in [6] involves a slight complication: morally, one would just set

$$v^2 = f_1(z)v + f_2(z) \quad (2.23)$$

and identify the residues of f_1 , which coincide with the residues of λ , with the mass parameters of the theory. Unfortunately the sum of the residues of f_1 is zero if f_1 is

a standard meromorphic function. To have a non-zero sum of residues, f_1 has to be a section of a non-trivial affine bundle on the torus, i.e. it must be allowed to shift by a constant around a cycle of the torus. v and f_2 must also transform appropriately for the shift to make sense. Fortunately for the case of $SU(2)$ this unpleasantness is immediately eliminated at the shift of $v \rightarrow x + 1/2f_1(t)$ which eliminates the linear term, bringing us back to the form

$$x^2 = \phi_2(z) \tag{2.24}$$

Again we keep $\lambda = xdz$, as the shift produces a useful shift in the definition of the flavor charges. We changed the notation from f_2 to ϕ_2 to remark that $\phi_2(z)$ is morally a quadratic differential, which is allowed double poles at $z = z_a$, with coefficients m_a^2 which are naturally identified with the mass parameters of the a -th $SU(2)$ flavor group in the chain. Indeed (x, z) live in $\mathbb{C} \times \mathbb{T}^2$, naturally identified with $T^*\mathbb{T}^2$.

Normalizable deformations can be parameterized by a shift $\phi_2(z) = \phi_2^{(0)}(z) + U(z)$ where U has simple poles only. Notice that there is no constraint on the coefficients of double poles of a meromorphic function on the torus. $\phi_2^{(0)}$ could be given by a simple sum of Weierstrass functions $\sum_a m_a^2 \rho(z - z_a)$. There are truly n independent mass parameters. Hence we have identified the gauge coupling parameter space as the Teichmüller moduli space $\tilde{\mathcal{M}}_{n,1}$ of a torus with n punctures. The S-duality group is $\pi_1(\mathcal{M}_{n,1})$. Again $\pi_1(\mathcal{M}_{n,1})$ acts as the permutation group on the n punctures, and acts in the same fashion on the $SU(2)$ factors of the flavor symmetry group, which are in one-to-one correspondence with the punctures.

A n punctured torus can degenerate to an $n + 2$ punctured sphere by pinching off a handle. Then the distance between a certain pair of consecutive punctures diverges, and by $\tau_a \sim z_{a+1} - z_a$ we see that one gauge group of the quiver has become very weakly coupled. The quiver degenerates to a simple linear quiver, indeed associated to a $n + 2$ punctured sphere. The quadratic differential on the torus naturally degenerates to a quadratic differential on the punctured sphere, with double poles at the two new punctures. The coefficients of the double poles are read by the contour integral $\int \sqrt{\phi_2}$ around the degenerating handle, and coincide as expected.

There are also degeneration limits where punctures on the torus collide. These are strong coupling limits for the original gauge groups on the quiver, and weak coupling limits for the appropriate choice of a S-dual generalized quiver in the ensemble $\mathcal{T}_{n,1}[A_1]$. It is easy to see that as the punctured torus degenerates to a torus with fewer punctures and a punctured sphere, the SW curve factorizes properly to the SW curves of the appropriate $\mathcal{T}_{n-m+1,1}[A_1]$ and $\mathcal{T}_{m+1,0}[A_1]$ theories. Ultimately, the set of possible complete degenerations of the n punctured torus is a graph of three punctured spheres with one loop. It coincides with the set of all possible weakly coupled generalized conformal quivers of n $SU(2)$ groups with one loop.

By analogy with the case of open and closed linear quivers, we are ready to associate to the ensemble of generalized quiver gauge theories with g loops and n $SU(2)$ flavor symmetry groups $\mathcal{T}_{n,g}$ the canonical SW curve in the cotangent bundle of a Riemann surface $C_{n,g}$ of

genus g and n punctures.

$$x^2 = \phi_2(z) \tag{2.25}$$

We will allow the quadratic differential to have simple poles at the n punctures of $C_{n,g}$. Mass deformations arise as double poles for the quadratic differential, of residue m^2 .

Notice that the linear space of quadratic differential with n simple poles on a Riemann surface of genus g has dimension $3g - 3 + n$, as they are in one-to-one correspondence with the complex moduli of the Riemann surface itself. Hence the dimension of the Coulomb branch of the generalized quiver is correctly reproduced: there is a u parameter for each of the $3g - 3 + n$ gauge groups. The gauge coupling moduli space of $\mathcal{T}_{n,g}$ is the same as $\mathcal{M}_{n,g}$. The S-duality group is $\pi_1(\mathcal{M}_{n,g})$. Again $\pi_1(\mathcal{M}_{n,g})$ acts as the permutation group on the n punctures, and we expect it to act in the same fashion on the $SU(2)$ factors of the flavor symmetry group, which are in one-to-one correspondence with the punctures.

The possible degeneration limits of $C_{n,g}$ to a collection of three-punctured spheres are in perfect correspondence with the set of all possible generalized quivers with g loops and n flavor groups. As $C_{n,g}$ degenerates, the quadratic differential develops double poles at the degeneration points. We can see the SW curve collapse to the curve for the three-punctured spheres, and $\mathcal{T}_{n,g}$ take the form of a very weakly coupled generalized quiver in the shape of the graph of three spheres (see figures in the previous subsection).

Again, it is important not to confuse the base Riemann surface with the covering SW curve. The moduli of the former are exactly marginal deformations of the $\mathcal{N} = 2$ SCFT, and only affect the positions of the poles of ϕ_2 . The period matrix of the SW curve gives the IR gauge couplings, and it depends on the position of the zeroes of $\phi_2(z)$.

2.3 An explicit construction from the $A_1(2,0)$ six dimensional SCFT

Some features of the SW curves described in the previous section may appear quite peculiar. The way the punctures on the base Riemann surface are associated with the factors of the flavor symmetry group is particularly intriguing. It is also interesting that a very weakly coupled $SU(2)$ gauge group should emerge whenever the gauge couplings are adjusted so that a handle of the surface is pinched off. There is a general construction for these theories, which explains such peculiarities.

The construction of the SW curves in [6] starts from a IIA brane setup whose decoupling limit yields the desired quiver. A lift to M-theory replaces the brane system with a single M5 brane wrapping a curve¹ in $\mathbb{C} \times \mathbb{C}^*$ (or $\mathbb{C} \times \mathbb{T}^2$ for elliptic models) which coincides with the SW curve. The KK reduction of the worldvolume $u(1)(2,0)$ six dimensional field theory on the curve leads to the correct IR $\mathcal{N} = 2$ abelian Lagrangian associated to the SW curve and appropriate SW differential. This single M5 brane is really the deformation of a simple set of several M5 branes. In the case of $SU(2)$ quiver gauge theories, one has two coincident M5 branes wrapping \mathbb{C}^* (and the four-dimensional space-time), which intersect at each of the locations $t_a \in \mathbb{C}^*$ a single transverse M5 branes wrapping \mathbb{C} (and spacetime).

¹Notice that often the direct M-theory lift actually leads to a curve in Taub-NUT space. There is a simple limiting procedure which brings certain D6 branes away from the region of interest, and converts Taub-NUT into $\mathbb{C} \times \mathbb{C}^*$ without affecting the complex structure of the curve. See [7] for the detailed limiting procedure

From the point of view of the worldvolume theory of the two coincident M5 branes, the deformation of the brane system to a single complicated M5 brane corresponds to an expectation value of the transverse scalars which describe the motion of the two M5 branes in \mathbb{C} . The scalars diverge at the location of the transverse M5 branes. At low energy, we can take a decoupling limit. The transverse M5 branes decouple for the four dimensional dynamics, and only appear as codimension two defects at $t = t_a$ in the $(2, 0)$ six-dimensional worldvolume theory of the two coincident M5 branes wrapping \mathbb{C}^* . The interacting worldvolume theory of two M5 branes is quite mysterious, but there are known BPS operators whose expectation value parameterizes the transverse motion of the two fivebranes (see for example [11, 12]). The two M5 branes are indistinguishable, and their positions are determined as the roots of a polynomial $v^2 = \phi_1(t)v + \phi_2(t)$. $\phi_{1,2}$ are the expectation values of BPS operators of dimension 2 and 4 respectively.

A look at the SW curve \mathcal{C} for the linear quiver,

$$\prod_{a=0}^n (t - t_a)v^2 = M_{n+1}(t)v + U_{n+1}(t) \quad (2.26)$$

indicates that the expectation value of the BPS operators should be identified with $M/\prod(t-t_a)$ and $U/\prod(t-t_a)$ respectively. The effect of the transverse M5 branes appears to be that the operators ϕ_1, ϕ_2 are allowed appropriate simple poles at the intersection points t_a . A related type of defect has been studied in the case of $\mathcal{N} = 4$ SYM [13]. It is useful to manipulate worldvolume theory of the two M5 branes in a similar way as we did to the SW equation. As we remove the linear term in v from the SW equation, we can strip off the center-of-mass degrees of freedom of the M5 brane pair, leaving a pure A_1 $(2, 0)$ six dimensional SCFT. Next, we would like to put the $t = 0, \infty$ punctures on the same footing as the $t = t_a$ punctures. This will require a small detour, as we need to learn how to define the $(2, 0)$ theory on the complex sphere. With an eye towards the general construction, we also want to be able to put the $(2, 0)$ theory on a generic Riemann surface while preserving 8 supercharges ($\mathcal{N} = 2$ in four dimensions).

This is readily done by a well known twisting procedure. The R-symmetry group of the $(2, 0)$ SCFT is $SO(5)$. The Poincaré supercharges transform in the $(4 \otimes 4)$ representation of $SO(5, 1) \times SO(5)$ with a symplectic Majorana reality constraint. We twist the holonomy of the theory on a Riemann surface by a $SO(2)_R$ subgroup of $SO(5)_R$. Under the subgroup $SO(3, 1) \oplus SO(2)_s \oplus SO(3)_R \oplus SO(2)_R$ the supercharges transform as

$$\left((2, 1)_{\frac{1}{2}} \oplus (1, 2)_{-\frac{1}{2}} \right) \otimes \left(2_{\frac{1}{2}} \oplus 2_{-\frac{1}{2}} \right) \quad (2.27)$$

After the twisting, we are left with

$$(2, 1; 2)_1 \oplus (2, 1; 2)_0 \oplus (1, 2; 2)_0 \oplus (1, 2; 2)_{-1} \quad (2.28)$$

This includes a $SO(3)_R$ doublet of scalar supercharges, which we identify with the $\mathcal{N} = 2$ four-dimensional supersymmetries. The central charge of the $\mathcal{N} = 2$ superalgebra is computed as the anticommutator of the supersymmetries in $(2, 1; 2)_0$ and turns out to

be the $\bar{\partial}$ operator on the Riemann surface. It follows that the chiral operators in four-dimensions are obtained from holomorphic operators on the Riemann surface. In particular the operator $\phi_2(z)$ has charge 2 under $SO(2)_R$, and becomes a quadratic differential after the twisting.

Protected quantities in the twisted theory should only depend on the complex structure of the Riemann surface, and not on the specific choice of metric on it. While the full six dimensional theory, even twisted, surely depends on the metric, we will make the crucial assumption that the four dimensional limit of the theory only depends on the complex structure of the surface. Notice that the far infrared information, as the prepotential of the IR abelian gauge theory, only depends on the complex structure of the Riemann surface, and even the BPS spectrum of the four dimensional theory is described by certain string webs [7] which are only sensitive to the complex structure.

When we map the theory from the cylinder \mathbb{C}^* to the complex sphere, we have seen that the expectation value of the quadratic differential

$$\phi_2 = \frac{P_{2n+2}(t)}{t^2 \prod_{a=0}^n (t - t_a)^2} dt^2 \quad (2.29)$$

has double poles of fixed coefficients both at the original punctures $t = t_a$ and at the new punctures at $t = 0, \infty$. We take this to be the defining properties of the codimension two defects in the A_1 theory. In their basic form, they allow ϕ_2 a simple pole at the location of the defect. They have a mass deformation parameter. Turning on the mass deformation m allows a second order pole for ϕ_2 , with coefficient m^2 .

Our second crucial assumption is that the four dimensional limit of the twisted $(2, 0)$ theory on the cylinder is equivalent to the four dimensional limit of the twisted $(2, 0)$ theory on the sphere with extra insertions of defect operators at $t = 0, \infty$. S-duality of the $SU(2)$ gauge theory with four flavors is a strong piece of evidence towards this assumption, as it requires the four punctures on the sphere to be indistinguishable. Again, neither the prepotential of the Abelian theory in the far infrared, nor the BPS spectrum can distinguish the difference between the punctures.

The direct relation between $SU(2)$ flavor symmetry groups and punctures suggests that the $SU(2)$ flavor symmetries truly live at the codimension two defects. If we conformally map the region near the puncture to a semi-infinite thin tube, we can reduce the A_1 $(2, 0)$ theory on the tube to a five-dimensional $SU(2)$ Young-Mills theory on a half line. The $SU(2)$ flavor symmetry at the defect is probably the four dimensional remnant of this five-dimensional theory. The mass parameter for this flavor symmetry can be interpreted as a boundary condition at infinity for the scalar fields on the half line.

Now we are in position to give a uniform definition of the $\mathcal{T}_{n,g}$ theories: the four dimensional limit of the twisted A_1 $(2, 0)$ six-dimensional field theory on a Riemann surface of genus g , in presence of n defect operators at the punctures, or equivalently on a non-compact Riemann surface of genus g with n semi-infinite tubular regions. The Coulomb branch of the theory is parameterized by the choice of quadratic differential $\phi_2(z)$. The SW curve and differentials take the expected form of a double cover of the Riemann surface

$$x^2 = \phi_2(z) \quad \lambda = x dz \quad (2.30)$$

and the complex structure moduli space of the Riemann surface $\mathcal{M}_{n,g}$ is a space of exactly marginal couplings for the theory.

This definition makes our conclusions regarding the degeneration limits for the Riemann surface quite obvious. In particular it sheds light on why a weakly coupled $SU(2)$ gauge group should appear in the degeneration limit. Intuitively, a long tube in the Riemann surface can be replaced by a long segment with a five-dimensional Young-Mills theory on it, which reduces to a weakly coupled four dimensional gauge theory.

3. $SU(3)$ generalized quivers

3.1 Argyres-Seiberg duality

The $\mathcal{N} = 2$ $N_f = 6$ $SU(3)$ gauge theory plays a crucial role in this section. The gauge coupling

$$\tau = \frac{\theta}{\pi} + \frac{8\pi i}{g^2} \quad (3.1)$$

is exactly marginal, because because the number of flavors is twice the number of colors. The theory is another simple example of a $\mathcal{N} = 2$ SCFT. The fundamental representation of $SU(3)$ is complex, hence the flavor symmetry is simply $U(6)$.

The moduli space of the theory has two distinct types of “weakly coupled” cusps (see fig. 18). The first type of cusps are simply S-dual images of the obvious weak coupling region $\tau \rightarrow i\infty$. At the second type of cusps, a new weakly coupled $SU(2)$ gauge group emerges. This phenomenon is the canonical example of Argyres-Seiberg duality [3]. At the second type of cusp, the $SU(2)$ gauge group is coupled weakly to a single fundamental hypermultiplet and to an $SU(2)$ subgroup of the E_6 flavor symmetry group of an interacting superconformal field theory, the E_6 theory. This $SU(2)$ subgroup is such that it commutes with an $SU(6)$ in E_6 . This $SU(6)$ together with the $SO(2)$ flavor symmetry of the single fundamental hypermultiplet reconstructs the $U(6)$ flavor symmetry of the full theory. The E_6 theory has a one-complex dimensional moduli space, parameterized by the expectation value u_3 of a dimension 3 operator. This is identified with the $Tr\Phi^3$ operator in the $SU(3)$ gauge theory. The dimension two operators in the $SU(2)$ theory and in the $SU(3)$ theory are identified with each other. Notice that the E_6 Lie algebra decomposes into the sum of $SU(6)$ and $SU(2)$ Lie algebras, together with a set of generators in the 20×2 of $SU(6) \times SU(2)$, i.e. in the three-indices antisymmetric representation of $SU(6)$ and fundamental of $SU(2)$.

Now, consider a linear quiver of $SU(3)$ gauge groups, with 3 flavors at each end node (see fig. 20). Such quivers are superconformal, as each node has 6 flavors. Each bifundamental hypermultiplet carries a $U(1)$ flavor symmetry. We can start with a configuration where all the gauge couplings are very weak, pick a middle node, and make the gauge coupling at that node strong. We see a strongly coupled $SU(3)$ gauge theory with six flavors, and a $SU(3) \times SU(3)$ subgroup of the $U(6)$ flavor symmetry is very weakly gauged at the neighboring nodes of the quiver. We expect to be able to apply Argyres-Seiberg duality at the strongly coupled node. In the dual weakly coupled frame we find an E_6 theory, together with the usual $SU(2)$ weakly coupled gauge group.

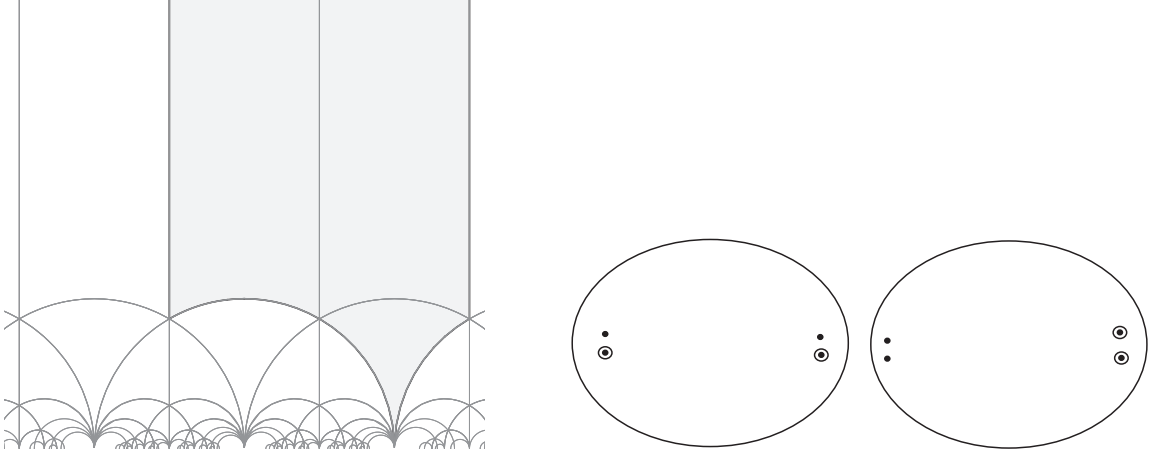

Figure 18: From left to right: the space of gauge couplings τ modulo S-duality for $SU(3)$ $N_f = 6$. It is the same as $\mathcal{M}_{(2,2),0}$, the space of spheres with two punctures of a type, two of another type. The degeneration limit of the four punctured sphere corresponding to the weakly coupled region at $\tau \rightarrow i\infty$. The degeneration limit of the four punctured sphere corresponding to the Argyres Seiberg dual weakly coupled region at $\tau \rightarrow 1$

The gauge groups at the neighboring nodes couple to an $SU(3) \times SU(3) \in SU(6)$ subgroup of the E_6 flavor symmetry. The remaining $U(1)$ in $SU(6)$, together with the $SO(2)$ flavor symmetry of the single fundamental flavor for $SU(2)$, are a mixture of the $U(1)$ flavor symmetries of the original pair of bifundamentals.

What happens if the gauge coupling of the new $SU(2)$ node is completely turned off? The single fundamental of $SU(2)$ will decouple. Furthermore, the flavor symmetry of the E_6 theory will grow to the commutant of the gauged $SU(3) \times SU(3)$ inside E_6 . This includes the $SU(2)$ we just ungauged and the $U(1)$ in $SU(6)$, but it is larger: the 20×2 of $SU(6) \times SU(2)$ decomposes under $SU(3) \times SU(3) \times U(1) \times SU(2)$ according to

$$20 = (1 \otimes 1)_3 \oplus (\bar{3} \otimes 3)_1 \oplus (3 \otimes \bar{3})_{-1} \oplus (1 \otimes 1)_{-3} \quad (3.2)$$

The $SU(3) \times SU(3)$ singlets reassemble a $SU(3)$ out of $U(1) \times SU(2)$. Indeed E_6 contains a $SU(3)_a \times SU(3)_b \times SU(3)_c$ subgroup. The $(\bar{3} \otimes 3)_1 \otimes 2$ pieces together with the remaining generators in $SU(6)$ can be recast in the pleasant form $(3_a \otimes 3_b \otimes 3_c) + c.c.$ (Here we replaced $\bar{3} \rightarrow 3_a$ for the first gauge group). The three $SU(3)$ subgroups of E_6 are identical. As the quiver is conformal, we learn that if any of the three $SU(3)$ subgroups of the E_6 is gauged, it will provide half of the amount of matter (same as 3 fundamentals) required for conformal symmetry. Hence the E_6 theory can play the same role in a generalized quiver of $SU(3)$ gauge groups as the blocks of four hypermultiplets plays in generalized quivers of $SU(2)$ groups. This motivates the depiction of fig. 19

We cannot directly produce the set of S-dual generalized quivers by simple dualities at each node, because we do not know the strong coupling limits of the nodes where $SU(3)$ is coupled to the E_6 theory. Instead, we will produce directly a large set of generalized quivers with similar properties which are candidates to be various S-dual weakly coupled

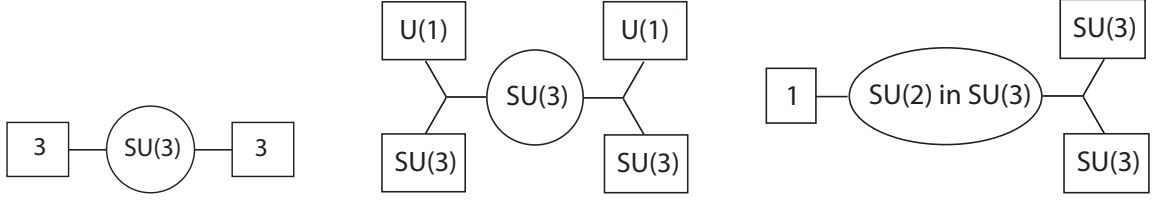

Figure 19: Different useful ways to depict $SU(3)$ gauge theory with six fundamental flavors. On the left, a quiver diagram where the six flavors have been split into two groups of three flavors; each group carries a $U(3) = SU(3) \times U(1)$ flavor symmetry. In the middle, a generalized quiver diagram, depicting separately the two $SU(3)$ and the two $U(1)$ flavor groups. On the right: Argyres-Seiberg S-dual frame: an $SU(2)$ gauge theory coupled to the E_6 theory and a single fundamental. We focus on a $SU(3) \times SU(3) \times SU(3)$ subgroup of E_6 , and represent the E_6 theory as a three pronged junction.

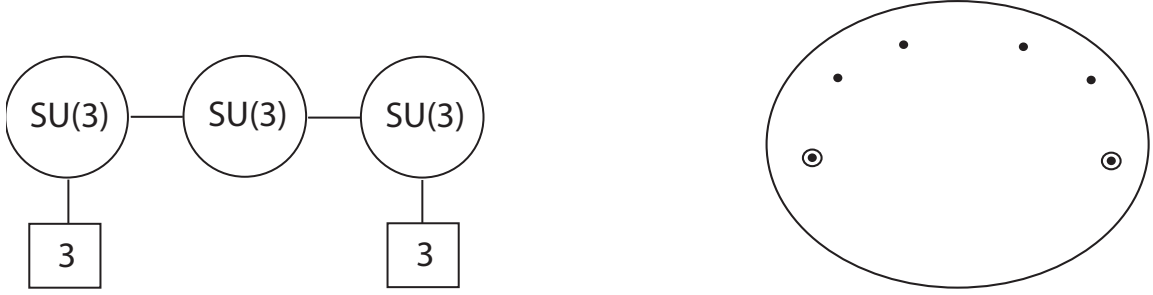

Figure 20: A simple conformal linear quiver of three $SU(3)$ gauge groups. The flavor symmetry group is $U(1)^4 \times SU(3)^2$. The gauge coupling parameter space of the theory is parameterized by a sphere with four punctures of the first type, two of the second type.

descriptions of the same theory, and then verify through the SW curve that they exhaust the set of possible “cusps” of the gauge coupling parameter space. One can start with a product of m_2 bifundamental blocks and m_3 E_6 theories with a choice of an $SU(3)_a \times SU(3)_b \times SU(3)_c$ subgroup, and introduce n_3 $SU(3)$ gauge groups, each coupled diagonally to any two of the $SU(3)$ flavor symmetries of the matter system. All the n_3 gauge couplings will be exactly marginal. Moreover, one can introduce n_2 $SU(2)$ gauge groups, each coupled to a single fundamental flavor and to an $SU(2)$ subgroup of an $SU(3)$ flavor symmetry group. Again, all the n_2 gauge couplings will be exactly marginal. The resulting generalized quiver gauge theory possesses $f_3 = 3m_3 + 2m_2 - 2n_3 - n_2$ $SU(3)$ residual flavor symmetry groups, $f_1 = m_2 + 2n_2$ $U(1)$ residual flavor symmetry groups. The number of loops of the graph is $g = n_3 + 1 - m_3 - m_2$. Notice that the three numbers f_1, f_3, g determine the dimension of the gauge coupling parameter space and of the Coulomb branch of the theory. The number of gauge couplings is $n_2 + n_3 = 3g - 3 + f_1 + f_3$. The Coulomb branch of the theory is parametrized by the expectation value of $n_3 + n_2 = 3g - 3 + f_1 + f_3$ dimension 2 operators and $n_3 + m_3 = 5g - 5 + f_1 + 2f_3$ dimension 3 operators. See fig. 21,22,22 for the three generalized quivers with $f_1 = 3, f_3 = 2, g = 0$. See fig. 24,25 for the two generalized quivers

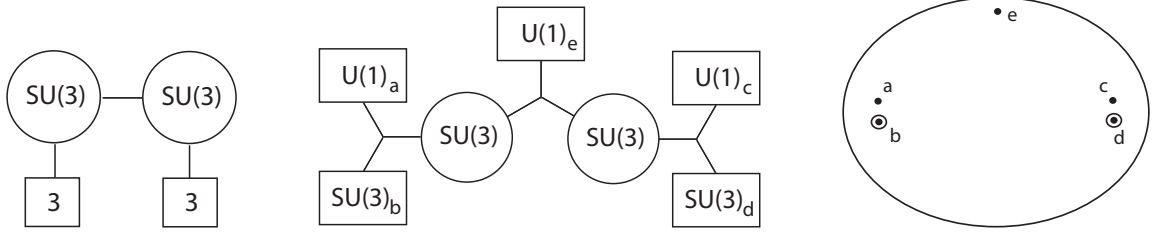

Figure 21: Left: A simple conformal linear quiver of two $SU(3)$ gauge groups. The flavor symmetry group is $U(1)^3 \times SU(3)^2$. Middle: same quiver, depicted as one of the generalized quivers with $f_1 = 3, f_2 = 2, g = 0$. Right: the cusp in the gauge coupling parameter space where this quiver description is weakly coupled.

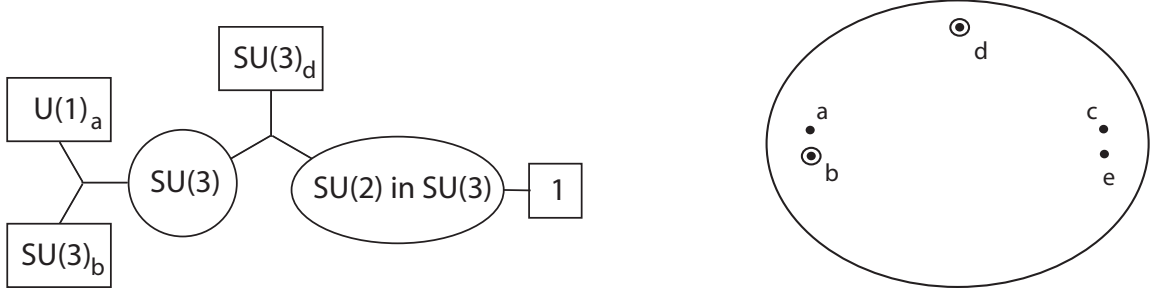

Figure 22: Left: Another generalized quiver with $f_1 = 3, f_2 = 2, g = 0$. The $U(1)_c \times U(1)_e$ factors are mixed in the flavor symmetry of the $SU(2)$ fundamental, and the commutant of $SU(2)$ in $SU(3)$. Right: the cusp in the gauge coupling parameter space where this generalized quiver description is weakly coupled.

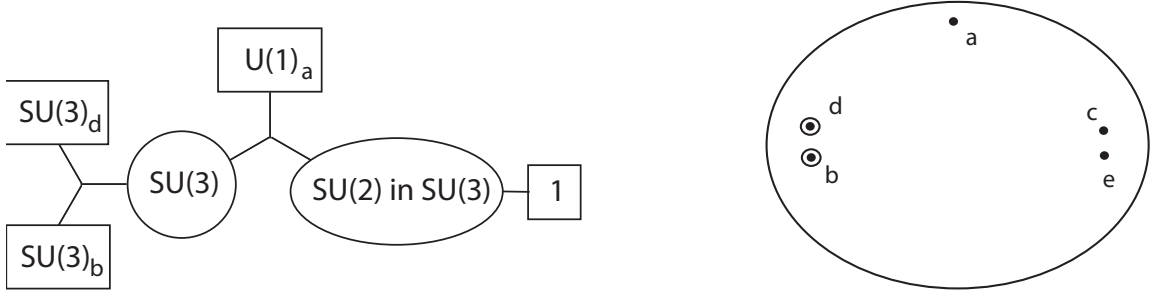

Figure 23: Left: The third and last generalized quiver with $f_1 = 3, f_2 = 2, g = 0$. The $U(1)_c \times U(1)_e$ factors are mixed in the flavor symmetry of the $SU(2)$ fundamental, and the commutant of $SU(2)$ in $SU(3)$. Right: the cusp in the gauge coupling parameter space where this generalized quiver description is weakly coupled.

with $f_1 = 1, f_3 = 1, g = 1$.

The rest of this section will be devoted to show that the set of all generalized quivers with g loops, f_1 and f_3 flavor symmetry groups coincides with the set of all weakly coupled duality frames for a single $\mathcal{N} = 2$ SCFT $\mathcal{T}_{(f_1, f_3), g}[A_2]$ with flavor symmetry group (at least)

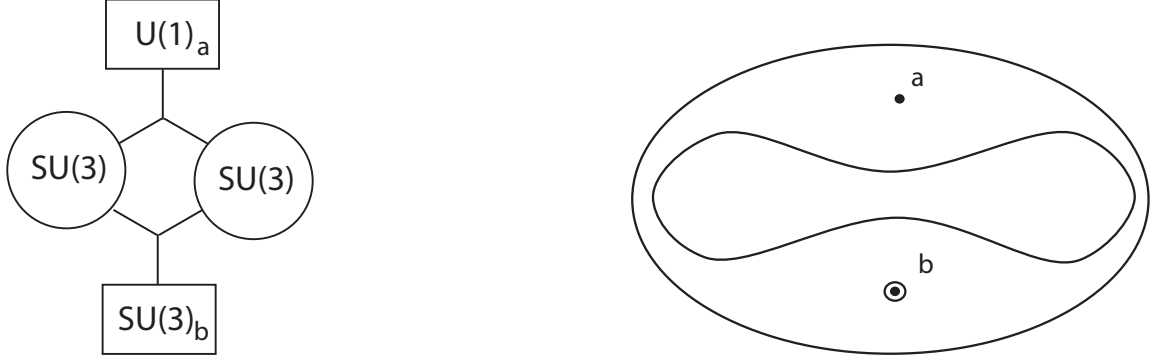

Figure 24: Left: A generalized quiver with $f_1 = 1, f_2 = 1, g = 1$. Right: the cusp in the gauge coupling parameter space where this generalized quiver description is weakly coupled.

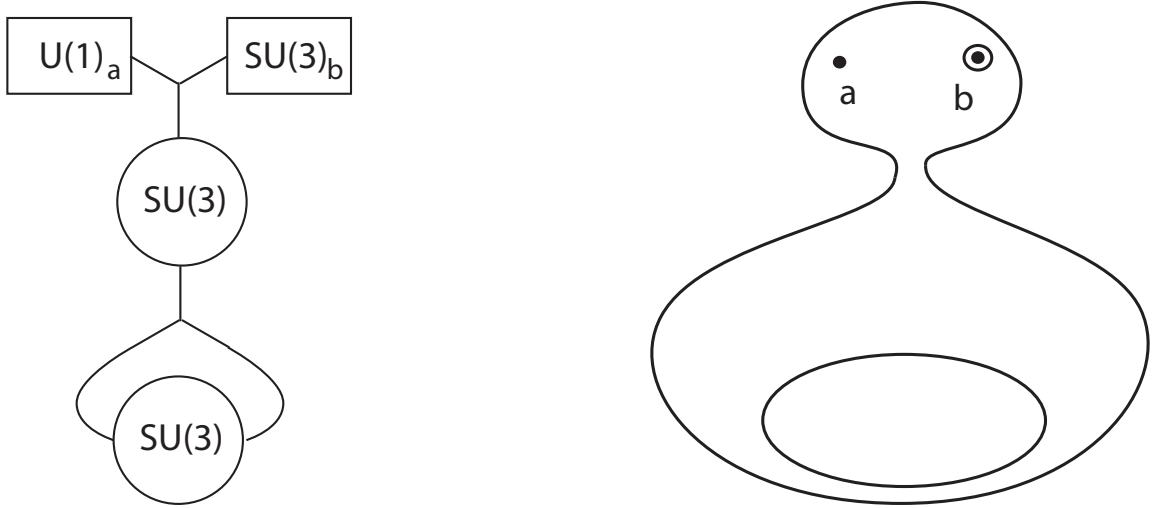

Figure 25: Left: The second and last generalized quiver with $f_1 = 1, f_2 = 1, g = 1$. Right: the cusp in the gauge coupling parameter space where this generalized quiver description is weakly coupled.

$SU(3)^{f_3} \times U(1)^{f_1}$. We will see that the gauge coupling parameter space of this theory coincides with the moduli space $\mathcal{M}_{(f_1, f_3), g}$ of Riemann surfaces of genus g with two types of puncture.

Let's sketch some steps of the derivation: we consider a linear quiver which has no $SU(3)$ flavor groups, and defines $\mathcal{T}_{(n+3, 0), 0}[A_2]$: a conformal linear quiver theory with gauge groups (in order) $SU(2) \times SU(3)^{n-2} \times SU(2)$ (see fig. 26). The gauge coupling moduli space of this theory is the moduli space of a sphere with $n + 3$ identical punctures. It has an S-duality group which permutes all punctures and $U(1)$ flavor symmetry groups freely.

We will see that the region in parameter space where the sphere degenerates, and $m + 1$ punctures on the sphere collide, corresponds in some S-dual frame to the weak coupling limit of the m -th gauge group of the quiver. If $m > 1$ the decoupling gauge group is a

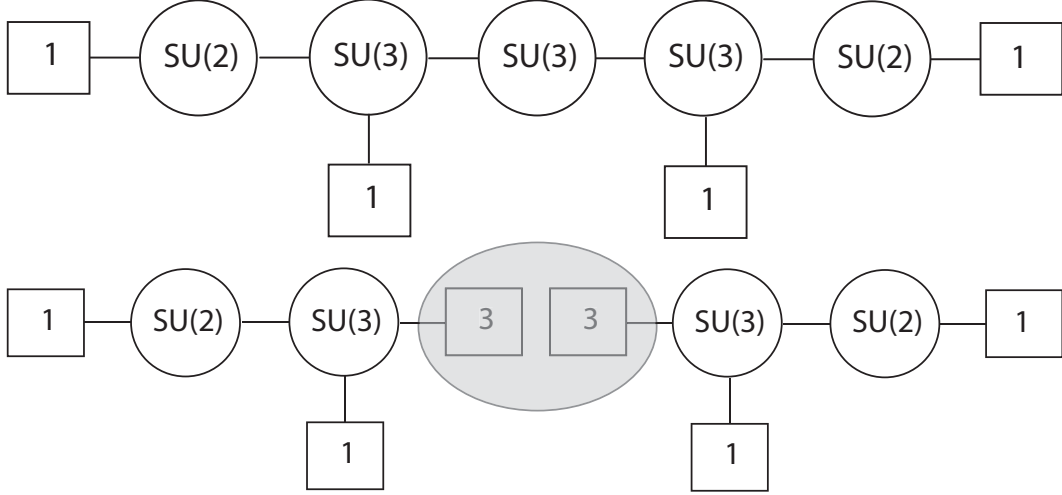

Figure 26: A simple conformal linear quiver of flavor symmetry group $U(1)^8$. and one simple decoupling limit.

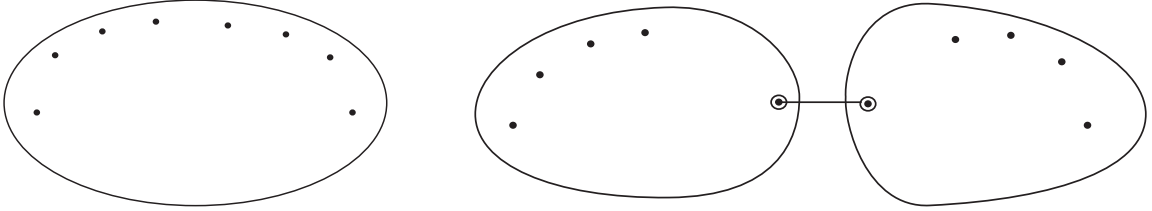

Figure 27: The gauge coupling parameter space for the fig. 26 is parameterized by a sphere with eight punctures of the first type, none of the second type.

$SU(3)$. The quiver decomposes into two subquivers (see fig. 27) labeled as $\mathcal{T}_{(m+1,1),0}[A_2]$ and $\mathcal{T}_{(n+2-m,1),0}[A_2]$. As a rule, punctures of the second type appear at degeneration points. The collision of two punctures of the first type is a bit special, in that only a $SU(2)$ gauge group becomes very weakly coupled. The nearby $SU(3)$ node is still coupled to three fundamental flavors with a $SU(3)$ flavor symmetry group. The remaining quiver is labeled as $\mathcal{T}_{(n+1,1),0}[A_2]$: the two punctures of the first type has coalesced to a single puncture of the second type with a $SU(3)$ flavor symmetry group. The decoupling $SU(2)$ gauge fields were coupled to a single fundamental hypermultiplet and to a $SU(2)$ subgroup of this $SU(3)$ flavor group.

We can start from the quiver for $\mathcal{T}_{(6,0),0}[A_2]$, and collide the six punctures pairwise. Because of S-duality all punctures are equivalent and three $SU(2)$ gauge groups must decouple in total. Two are simply the two manifest $SU(2)$ gauge groups of the quiver (see fig. 28). The third is the hidden $SU(2)$ in the strong coupling region of the $SU(3)$ node. Decoupling the three $SU(2)$ gauge groups must leave behind a theory with three $SU(3)$ flavor symmetry groups. As any pair of $SU(3)$ is actually part of an $SU(6)$, one can derive the full E_6 flavor symmetry group of the theory. Hence S-duality of $\mathcal{T}_{(6,0),0}[A_2]$ implies

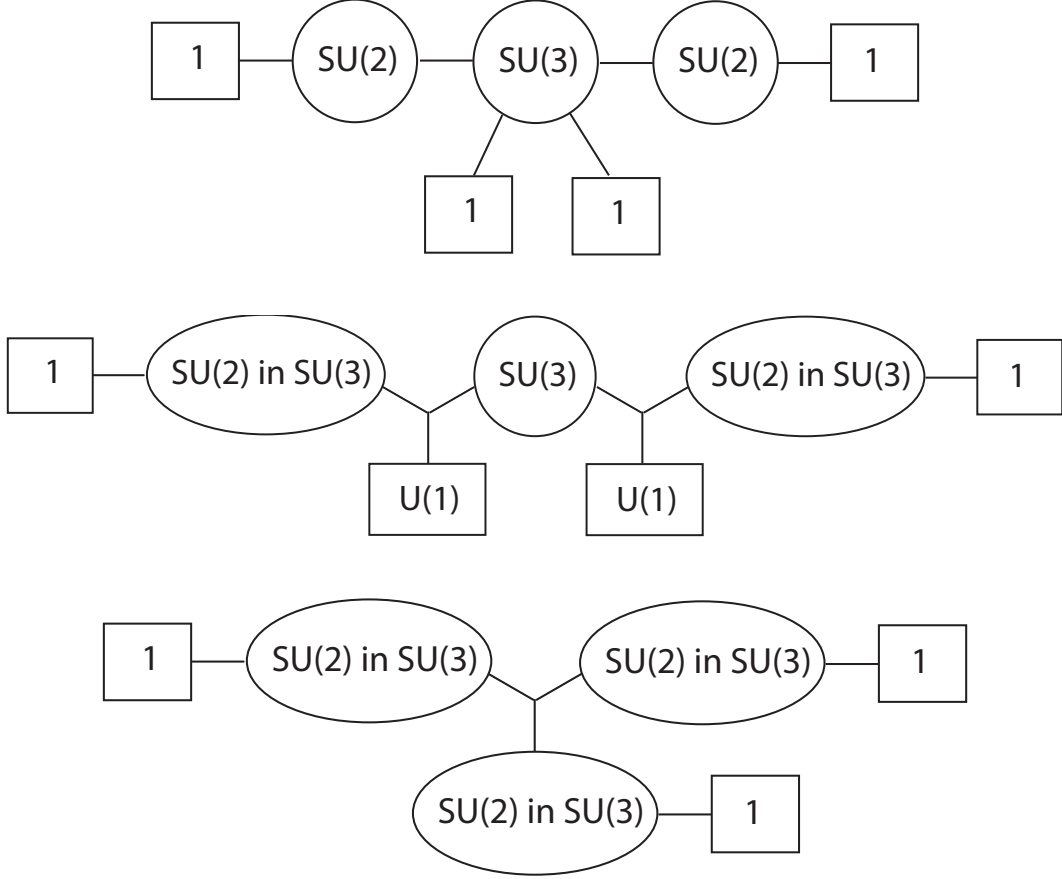

Figure 28: Top: A simple conformal linear quiver realization of $\mathcal{T}_{(6,0),0}[A_2]$. Colliding punctures pairwise decouples three $SU(2)$ gauge groups. Two are visible in the original quiver, the last must emerge in the very strong coupling region of the middle $SU(3)$ node. Middle: the same quiver, depicted as a generalized quiver. Bottom: the result of the pairwise collision of punctures must take this symmetric form. The three-pronged theory $\mathcal{T}_{(0,3),0}[A_2]$ is identified with the E_6 theory

Argyres-Seiberg duality. The E_6 theory is represented by a sphere with three punctures of the second type, and can be denoted as $\mathcal{T}_{(0,3),0}[A_2]$.

We can define $\mathcal{T}_{(f_1,f_3),0}[A_2]$ from a very strongly coupled limit of $\mathcal{T}_{(f_1+2f_3,0),0}[A_2]$, by colliding f_3 pairs of punctures of the first type. f_3 $SU(2)$ gauge groups decouple, and leave behind f_3 $SU(3)$ flavor symmetry groups. Combining the information about all possible degeneration limits of $\mathcal{T}_{(n+3,0),0}[A_2]$, we see that at a generic cusp, where the $f_2 + f_3$ punctured sphere degenerates to a binary tree of three-punctured spheres, $\mathcal{T}_{(f_1,f_3),0}[A_2]$ also decomposes into elementary building blocks coupled by $SU(3)$ or $SU(2)$ gauge groups. Furthermore, we see the three possible building blocks: $\mathcal{T}_{(0,3),0}[A_2]$ represents the E_6 theory, $\mathcal{T}_{(1,2),0}[A_2]$ bifundamentals for $SU(3) \times SU(3)$. Spheres with two punctures of the first type are a bit of an exception, as they are “connected” to the rest of the theory by an $SU(2)$ gauge group only, and they simply represent the lone fundamental for $SU(2)$ (See an example in fig. 29). Every cusp in the gauge coupling parameter space of $\mathcal{T}_{(f_1,f_3),0}[A_2]$ has

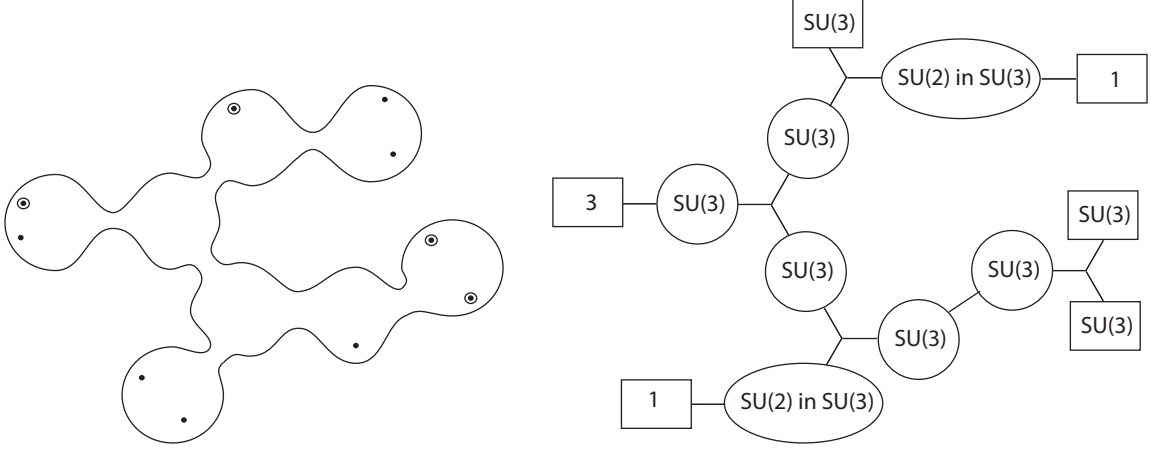

Figure 29: From left to right: A generic degeneration limit of $\mathcal{T}_{(6,4),0}[A_2]$ and the corresponding weakly coupled generalized quiver description. For clarity we suppressed the $U(1)$ flavor groups, and represented fundamentals and bifundamentals simply as a line.

a weakly coupled generalized quiver description.

We can also gauge pairs of $SU(3)$ flavor symmetry groups to produce generalized quivers with loops $\mathcal{T}_{(f_1, f_3), g}[A_2]$. In that case, we have to conjecture a Seiberg-Witten curve, and there is a very natural conjecture based on a Riemann surface $C_{(f_1, f_3), g}$. At the boundary of $\mathcal{M}_{(f_1, f_3), g}$ either a handle pinches off, and $\mathcal{T}_{(f_1, f_3), g}[A_2]$ degenerates to $\mathcal{T}_{(f_1, f_3+2), g-1}[A_2]$, or the Riemann surface splits in two, and correspondingly $\mathcal{T}_{(f_1, f_3), g}[A_2]$ degenerates to $\mathcal{T}_{(f'_1, f'_3+1), g'}[A_2]$ and $\mathcal{T}_{(f_1-f'_1, f_3-f'_3+1), g-g'}[A_2]$. At cusps of $\mathcal{M}_{(f_1, f_3), g}$ we find all possible degeneration limits of a Riemann surface with f_1 punctures of the first type, f_3 of the second type into of a graph of three-punctured spheres, joined at nodal singularities, corresponding to all generalized quivers labeled by f_1, f_3, g . In particular all pictures of generalized $SU(2)$ quivers $\mathcal{T}_{n, g}[A_1]$ in the section 2 can be adapted to represent generalized $SU(3)$ quivers $\mathcal{T}_{(0, n), g}[A_2]$, simply replacing the blocks of four hypermultiplets with an E_6 theory, and the $SU(2)$ gauge groups with $SU(3)$ gauge groups.

The reader should not think that our definition of generalized quivers and computations of SW curves, S-dualities etc. covers all conformal quivers of $SU(2)$ and $SU(3)$ gauge groups. There is a single exception, depicted in fig. 30, where we gauge the enhanced $U(2)$ flavor symmetry of $\mathcal{T}_{(6,0),0}[A_2]$ to produce a result which falls outside the class $\mathcal{T}_{(f_1, f_3), g}[A_2]$. Notice that the theory has only 6 $U(1)$ flavor symmetry groups, but a four dimensional gauge coupling parameter space. Any member of the class $\mathcal{T}_{(6,0), g}[A_2]$ would have had $3g + 3$ dimensional gauge coupling parameter space. Furthermore, Argyres-Seiberg duality at the middle node produces an E_6 theory where four identical $SU(2)$ subgroups have been gauged.

Quivers of this shape, a D-type Dynkin diagram, are still amenable of a brane analysis using orbifold fiveplanes (see section 5 for more details)

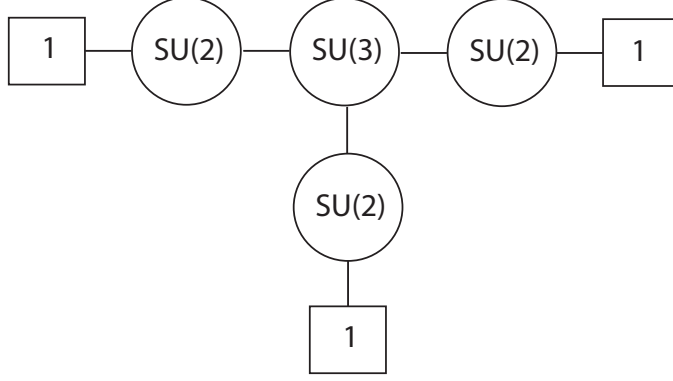

Figure 30: The exceptional quiver.

3.2 SW curves

Again we will use the final result of [6], specialized to a product of n $SU(3)$ gauge groups with three hypermultiplets at each end. We will follow closely the analysis for the quiver of $SU(2)$ gauge groups. The curve is given as a polynomial equation in two variables (v, t) , defined in $\mathbb{C} \times (\mathbb{C}^* - \{t_0, \dots, t_n\})$. The polynomial is of third order in v and order $n + 1$ in t . If we collect the same powers of t it can be written as

$$v^3 t^{n+1} + c_1(v^3 - u_1^{(2)}v - u_1^{(3)})t^n + \dots + c_n(v^3 - u_n^{(2)}v - u_n^{(3)})t + c_{n+1}v^3 = 0 \quad (3.3)$$

The $u_i^{(d)}$ coefficients parameterize the Coulomb branch of the theory. At weak coupling, $u_i^{(d)}$ should be identified with the expectation value $Tr\Phi_i^d$ for the i -th $SU(3)$ gauge group in the quiver. The c_i parameterize the space of gauge couplings of the theory. We can collect the same powers of v as

$$\prod_{a=0}^n (t - t_a)v^3 = U_{n-1}^{(2)}(t)tv + U_{n-1}^{(3)}(t)t \quad (3.4)$$

then at weak coupling

$$\tau_a = \frac{1}{i\pi} \log \frac{t_{a-1}}{t_a} \quad (3.5)$$

The overall rescaling of t_a is immaterial. We can set, for example, $t_0 = 1$.

The Seiberg Witten differential has the familiar expression (See section 2 for more details)

$$\lambda = v \frac{dt}{t} \quad (3.6)$$

Let us specialize to the case $n = 1$. The curve equation is

$$(t - 1)(t - t_1)v^3 = u^{(2)}tv + u^{(3)}t \quad (3.7)$$

This form of the equation needs some improvements. Following the example of the $SU(2)$ analysis, we write $v = tx$, so that $\lambda = xdt$, and the curve becomes

$$x^3 = \frac{u^{(2)}}{(t - 1)(t - t_1)t}x + \frac{u^{(3)}}{(t - 1)(t - t_1)t^2} \quad (3.8)$$

This is the first example of a canonical form for the SW curve of a generalized $SU(3)$ quiver.

$$x^3 = \phi_2(z)x + \phi_3(z) \quad (3.9)$$

(x, z) are local coordinates in the cotangent bundle of some punctured Riemann surface. The SW differential is the canonical one form $x dz$, $\phi_2(z) dz^2$ is a quadratic differential and $\phi_3(z) dz^3$ a cubic differential on the punctured Riemann surface with appropriate poles at the puncture. In the case of the $SU(3)$ $N_f = 6$ the quadratic differential $\phi_2(t) dt^2$ has simple poles at $t = 0, 1, t_1, \infty$. The cubic differential $\phi_3(t) dt^3$ has simple poles at $t = 1, t_1$, and double poles at $t = 0, \infty$. We see that the punctures at $t = 0, \infty$ have different properties than the punctures at $t = 1, t_1$. We will call punctures where the cubic differential has a simple pole ‘‘punctures of the first type’’, and punctures where the cubic differential has a double pole ‘‘punctures of the second type’’.

The original weak coupling region for the $SU(3)$ gauge theory is $t_1 \gg 1$. Traditional S-duality acts by the fractional linear transformation $t \rightarrow 1/t, x \rightarrow -t^2 x$. The S-duality invariant moduli space is the moduli space of a sphere with two punctures of one type, and two of another type, indicated here as $\mathcal{M}_{(2,2),0}$.

The Argyres-Seiberg dual frame is weakly coupled in the degeneration limit where t_1 is close to 1. If we set $t_1 = 1$ and turn off the $u^{(2)}$ parameter, we decouple the new $SU(2)$ degrees of freedom and the SW curve becomes the curve for the E_6 theory:

$$x^3 = \frac{u^{(3)}}{(t-1)^2 t^2} \quad (3.10)$$

There is a perfect symmetry between the punctures at $t = 0, 1, \infty$. The cubic differential has a double pole at all punctures. We will associate the three punctures with the three $SU(3)$ flavor symmetry subgroups of E_6 which played a key role in the previous subsection. Let us consider the more general linear quiver of $SU(3)$ gauge groups.

$$x^3 = \frac{U_{n-1}^{(2)}(t)}{\prod_{a=0}^n (t-t_a)t} x + \frac{U_{n-1}^{(3)}(t)}{\prod_{a=0}^n (t-t_a)t^2} \quad (3.11)$$

The quadratic differential $\phi_2(t) dt^2$ has simple poles at all punctures $t = 0, \dots, t_a, \dots, \infty$. The cubic differential $\phi_3(t) dt^3$ has simple poles at the $n+1$ punctures $t = t_a$, and double poles at $t = 0, \infty$. The gauge coupling moduli space is the moduli space of a sphere with $n+1$ punctures of one type, 2 of another type $\mathcal{M}_{(n+1,2),0}$. Notice that the quiver gauge theory has $n+1$ $U(1)$ flavor symmetry groups, and 2 $SU(3)$ flavor symmetry groups.

Can we modify this quiver in such a way that all punctures are equivalent? In the case of $SU(3)$ $N_f = 6$, ungauging the $SU(2)$ group in the Argyres-Seiberg dual frame coincided with the degeneration limit where the two punctures of first type at $t = 1, t_1$ merge into a single puncture of second type, identical to the punctures at $t = 0, \infty$. We would like now to do the opposite: replace each of the punctures of second type at $t = 0, \infty$ with a pair of punctures of the first type. It is surprisingly simple to archive that result. We will add two new $SU(2)$ nodes to the quiver. The new superconformal linear quiver, $\mathcal{T}_{(n+3,0),0}[A_2]$, has gauge groups $SU(2) \times SU(3)^{n-2} \times SU(2)$. (The order of the factors indicates the position

along the quiver). Superconformal invariance requires a single fundamental hypermultiplet at the $SU(2)$ nodes, and a single fundamental hypermultiplet at the first and last $SU(3)$ nodes.

The SW curve for such a quiver can be computed in the general framework of [6]. It can be written as

$$v^3 t^{n+1} + c_1 v(v^2 - u_1^{(2)}) t^n + c_2 (v^3 - u_2^{(2)} v - u_2^{(3)}) t^{n-1} \dots + \quad (3.12)$$

$$c_{n-1} (v^3 - u_{n-1}^{(2)} v - u_{n-1}^{(3)}) t^2 + c_n v(v^2 - u_n^{(2)}) t + c_{n+1} v^3 = 0 \quad (3.13)$$

with the usual SW differential. We can collect the same powers of $v = tx$ to get

$$x^3 = \frac{U_{n-1}^{(2)}(t)}{\prod_{a=0}^n (t - t_a) t} x + \frac{U_{n-3}^{(3)}(t)}{\prod_{a=0}^n (t - t_a) t} \quad (3.14)$$

As desired, both $\phi_2(t) dt^2$ and $\phi_3(t) dt^3$ have now simple poles at all $n + 3$ punctures $0, \dots, t_a, \dots, \infty$. This indicates that the theory has a large S-duality group, similar to the one for $SU(2)$ linear quivers, which can permute the punctures freely. The correct gauge moduli space of this theory should be $\mathcal{M}_{n+3,0}$, the moduli space of a sphere with $n + 3$ identical punctures.

We can use a fractional linear transformation to put all punctures on the same footing.

$$x^3 = \frac{U_{n-1}^{(2)}(z)}{\Delta_{n+3}(z)} x + \frac{U_{n-3}^{(3)}(z)}{\Delta_{n+3}(z)} \quad (3.15)$$

Notice that the theory has a flavor symmetry $U(1)^{n+3}$. It is natural to assume that each $U(1)$ group is associated to a puncture of the first type. We will verify that momentarily by looking at mass deformations. First though lets write down the SW curve naturally associated to a theory $\mathcal{T}_{(f_1, f_3), 0}[A_2]$, with f_1 punctures of the first type, and f_2 of the second type.

$$x^3 = \frac{U_{f_1+f_3-4}^{(2)}(z)}{\Delta_{f_1}(z) \Delta_{f_3}(z)} x + \frac{U_{f_1+2f_3-6}^{(3)}(z)}{\Delta_{f_1}(z) \Delta_{f_3}^2(z)} \quad (3.16)$$

Now we should introduce mass deformations. The mass-deformed SW curve for $\mathcal{T}_{(n+3,0),0}$ is given in [6] as

$$\begin{aligned} & (v - m_1)(v - m_2)^2 t^{n+1} + c_1 (v - m_2)(v^2 - m_3 v - u_1^{(2)}) t^n + \\ & + c_2 (v^3 - m_4 v^2 - u_2^{(2)} v - u_2^{(3)}) t^{n-1} \dots + c_{n-1} (v^3 - m_{n+1} v^2 - u_{n-1}^{(2)} v - u_{n-1}^{(3)}) t^2 + \\ & + c_n (v - m_{n+3})(v^2 - m_{n+2} v - u_n^{(2)}) t + c_{n+1} (v - m_{n+3})^2 (v - m_{n+4}) = 0 \end{aligned} \quad (3.17)$$

Because of the freedom $v \rightarrow v + v_0$ only $n + 3$ mass parameters are physical. We can collect the same powers of v

$$\prod_{a=0}^n (t - t_a) v^3 = M_{n+1}(t) v^2 + V_{n+1}^{(2)}(t) v + V_{n+1}^{(3)}(t) \quad (3.18)$$

The coefficients of the polynomials $M, V^{(d)}$ will not be quite generic, because of the specific pattern of $(v - m_i)$ factors in 3.17. This pattern affects the asymptotic behavior of the roots $v_\alpha(t)$ at $t = 0, \infty$. As $t \rightarrow \infty$

$$v_\alpha(t) \sim (m_1 + O(1/t), m_2 + O(1/t), m_2 + O(1/t)) \quad (3.19)$$

and similarly as $t \rightarrow 0$,

$$v_\alpha(t) \sim (m_{n+4} + O(t), m_{n+3} + O(t), m_{n+3} + O(t)) \quad (3.20)$$

The SW differential has poles at all punctures $t = 0, \dots, t_a, \dots, \infty$. At $t = t_a$ a single root $v_\alpha(t)$ out of three has a pole, leading directly to a pole in the SW differential. The residue is identified with the mass parameter for the $U(1)$ flavor symmetry of the a -th bifundamental hypermultiplet. The identification of the mass parameters of the fundamental hypermultiplets requires a little bit of care. For example the residue at $t = t_1$ is the mass parameter for an overall rotation of both the 2×3 bifundamentals between the first and second node, and the fundamental at the second node. m_1 and m_2 are mass parameters for $U(1)$ rotations of the fundamentals at the first and second node respectively.

Things become a bit cleaner if we remove the linear term in v by shifting v by $\frac{M}{\Delta} dt$ and set $v = tx$. As in the case of $SU(2)$ quivers we keep $\lambda = xdt$, and accept the corresponding shift in the definition of the $U(1)$ flavor symmetries as welcome. After the shift of v the SW differential has poles on all three branches of $x_\alpha(t)$ at all $n + 3$ punctures. The shift of v can only modify the residues of the poles at $t = t_a$ from some $(3\tilde{m}_a, 0, 0)$ to $(2\tilde{m}_a, -\tilde{m}_a, -\tilde{m}_a)$. Similarly the residues of the poles at $t = 0, \infty$ will go from something of the form (m_1, m_2, m_2) to something of the form $(2\tilde{m}, -\tilde{m}, -\tilde{m})$.

We see once more that the behavior of the SW curve and differential at all $n + 3$ punctures is equivalent. We can do the standard manipulations to bring it to the symmetric form

$$x^3 = \frac{P_{2n+2}^{(2)}(z)}{\Delta_{n+3}(z)^2} x + \frac{P_{3n+3}^{(3)}(z)}{\Delta_{n+3}(z)^3} \quad (3.21)$$

The condition on the residue of $\lambda = xdt$ at the zeroes of Δ_{n+3} can be written as a factorization of the discriminant:

$$4P_{2n+2}^{(2)}(z)^3 - 27P_{3n+3}^{(3)}(z)^2 = \Delta_{n+3}^2(z)Q_{4n}(z) \quad (3.22)$$

which guarantees that there are two roots whose difference does not diverge at the punctures. A simple check is in order: $(2n + 3) + (3n + 4)$ coefficients of $P^{(2,3)}$ with $2n + 6$ relations from the factorization of the discriminant gives $3n + 1$ independent numbers. $n + 3$ mass parameters, $n u_a^{(2)}$ and $n - 2 u_a^{(3)}$ moduli also give a total of $3n + 1$.

To understand the mass deformation of a theory with punctures of the second type, we can observe the mass deformations of the linear quiver of $SU(3)$ groups which define $\mathcal{T}_{(f_1, 2), 0}$. The polynomials of v in

$$\prod_a (t - t_a) v^3 = M_{n+1}(t) v^2 + V_{n+1}^{(2)}(t) v + V_{n+1}^{(3)}(t) \quad (3.23)$$

are now unrestricted. In particular v assumes three generic values at $t = 0$ and at $t = \infty$. After removing the term linear in v , the residues of the SW differential at $t = 0, \infty$ become of the generic form $(m_1 + m_2, -m_1, -m_2)$. This is identified with the Cartan of the $SU(3)$ flavor symmetry group of the three fundamental flavors at either end of the quiver.

We are in position to write the mass deformed SW curve for the $\mathcal{T}_{(f_1, f_3), 0}$ theory

$$x^3 = \frac{P_{2f_1+2f_2-4}^{(2)}(z)}{\Delta_{f_1}(z)^2 \Delta_{f_3}(z)^2} x + \frac{P_{3f_1+3f_2-6}^{(3)}(z)}{\Delta_{f_1}(z)^3 \Delta_{f_3}(z)^3} \quad (3.24)$$

Only the residues at the f_1 punctures are constrained

$$4P_{2f_1+2f_2-4}^{(2)}(t)^3 - 27P_{3f_1+3f_2-6}^{(3)}(t)^2 = \Delta_{f_1}^2(t) Q_{4f_1+6f_2-12}(t) \quad (3.25)$$

We would like to caution the reader that there is a marked difference between a puncture of the first type where the residues of λ are of the form $(2m_1, -m_1, -m_1)$ and the $m_2 \rightarrow m_1$ limit of a puncture of the second type where the residues are generic $(m_1 + m_2, -m_1, -m_2)$. Careful inspection shows that in the latter case the difference between the two roots of λ will still not be finite, but diverge as $(t - t_a)^{-1/2}$. λ is not even single valued around t_a in that case. Notice that the limit $m_2 \rightarrow m_1$ gives a single zero in the discriminant, instead of the double zero required in (3.22).

Now we have all tools needed to study the degeneration limits in the gauge coupling moduli space, to recover the generalized quiver construction for $\mathcal{T}_{(f_1, f_3), 0}[A_2]$. Let us start again from the basic theory $\mathcal{T}_{(n, 0), 0}[A_2]$ with punctures of the first type only, and mass parameters turned off. If we consider the boundary of the gauge coupling parameter space where any number m of punctures come together, we can always go in a duality frame where the m punctures are at $t = 0, t_0, \dots, t_{m-2}$. As in the $SU(2)$ examples, when the punctures are brought together to zero, $2\pi i \tau_{m-1} \sim \log t_{m-2}/t_{m-1}$ diverges and the $m - 1$ -th node of the quiver becomes infinitely weakly coupled.

If $m = 2$, the decoupling gauge group is $SU(2)$, coupled to a single fundamental hypermultiplet and to the remaining part of the quiver, which now has an $SU(3)$ end node with three fundamental flavors. The SW curve for the latter quiver is easily written down with the usual methods, and brought to the canonical form $\mathcal{T}_{(n+1, 1), 0}$ with $n - 2$ punctures of the first type, and one of the second type associated with the $SU(3)$ flavor symmetry of the three fundamental flavors. As $t_0 \rightarrow 0$ two simple poles of the quadratic and cubic differentials converge to a double pole. This is the expected mass deformed puncture of the second type: the lack of an order three pole for the cubic differential indicates that one of the mass eigenvalues for the $SU(3)$ flavor symmetry is zero, and the SW differential will have residues $(m_1, -m_1, 0)$. m_1^2 is the coefficient of the double pole of ϕ_2 , and is naturally identified with the u parameter of the decoupling $SU(2)$ gauge group.

If $n - 1 > m > 2$ then the decoupling gauge group is an $SU(3)$ and the quiver breaks down to two subquivers, $\mathcal{T}_{(n+3-m, 1), 0}[A_2]$ and $\mathcal{T}_{(m, 1), 0}[A_2]$. The $n + 3$ punctured sphere is indeed degenerating to the union of two spheres joined at a nodal singularity. We see that at the degeneration points, punctures of the second type appear at the node. This is very natural: the decoupling $SU(3)$ gauge group leaves behind two $SU(3)$ flavor symmetry

groups. It is simple to verify that if we start from the general mass deformed expression

$$x^3 = \frac{P_{2f_1+2f_2-4}^{(2)}(z)}{\Delta_{f_1}(z)^2 \Delta_{f_3}(z)^2} x + \frac{P_{3f_1+3f_2-6}^{(3)}(z)}{\Delta_{f_1}(z)^3 \Delta_{f_3}(z)^3} \quad (3.26)$$

and we collapse any number of punctures, while keeping the residues of λ fixed, the quadratic and cubic differentials will have generic poles of degree 2 and 3 respectively at the resulting new puncture.

Notice that if $m = 3$, the decoupling $SU(3)$ gauge group was the first of last $SU(3)$ node of the quiver. The decoupling limit leaves behind three fragments: $\mathcal{T}_{(n,1),0}[A_2]$, a fundamental of $SU(3)$ and a $SU(2)$ gauge theory coupled to $3 + 1$ fundamentals. We expected $\mathcal{T}_{(3,1),0}[A_2]$. Notice that the overall degree of the poles for ϕ_3 is only $3 \times 1 + 1 \times 2 = 5$, and is too small for a non-zero cubic differential on the sphere (which has an overall degree at least 6). The Seiberg-Witten curve for $\mathcal{T}_{(3,1),0}[A_2]$ is degenerate

$$x(x^2 - \frac{u_2}{t(t-1)(t-t_1)}) = 0 \quad (3.27)$$

and truly reduces to the SW curve for $SU(2)$ $N_f = 4$. It is interesting though to keep the mass deformations for the type 2 puncture (say at $t = \infty$), which came from the u_2, u_3 parameters of the decoupling $SU(3)$. The ϕ_3 is not zero anymore

$$x^3 = \frac{u_2 + \tilde{m}_2 t}{t(t-1)(t-t_1)} x + \frac{\tilde{m}_3}{t(t-1)(t-t_1)} \quad (3.28)$$

This is an unusual form a mass-deformed $SU(2)$ $N_f = 4$ which makes manifest the $SU(3)$ subgroup of flavor symmetry. It takes some work to bring it to a standard form. The simplest way is to go back to $\mathbb{C} \times \mathbb{C}^*$ by the $x \rightarrow v/t$

$$(t-1)(t-t_1)v^3 = (u_2 + \tilde{m}_2 t)tv + \tilde{m}_3 t^2 \quad (3.29)$$

Collect the same powers of t

$$(v^3 - \tilde{m}_2 v - \tilde{m}_3)t^2 - ((t_1 + 1)v^2 + u_2)vt + t_1 v^3 \quad (3.30)$$

If we factor

$$(v^3 - \tilde{m}_2 v - \tilde{m}_3) = (v - m_1)(v - m_2)(v + m_1 + m_2) \quad (3.31)$$

then we can redefine $(v + m_1 + m_2)t = v\tilde{t}$ and get the familiar form

$$(v - m_1)(v - m_2)\tilde{t}^2 - (t_1 + 1)(v^2 + \tilde{u}_2)\tilde{t} + t_1 v(v + m_1 + m_2) \quad (3.32)$$

The coordinate transformation $(v + m_1 + m_2)t = v\tilde{t}$ does not preserve the fibration structure of the Seiberg-Witten curve. $\mathcal{T}_{(3,1),0}[A_2]$ is a construction of $SU(2)$ $N_f = 4$ from the A_2 (2,0) SCFT, which makes manifest a $U(1)^3 \times SU(3)$ subgroup of the flavor group.

It is clear that the theory $\mathcal{T}_{(f_1, f_3), 0}[A_2]$ can be engineered from the $\mathcal{T}_{(f_1+2f_3, 0), 0}[A_2]$ quiver by colliding f_3 pairs of punctures of the first type. In terms of the original quiver, this operation will typically push some $SU(3)$ gauge coupling to the very strongly coupled

region, so that a total of f_3 $SU(2)$ gauge groups decouple. The gauge coupling parameter space $\mathcal{M}_{(f_1, f_3), 0}$ of $\mathcal{T}_{(f_1, f_3), 0}[A_2]$ has various cusps, where the $f_1 + f_3$ punctured sphere degenerates to a tree of three-punctures spheres joined by nodal singularities. Our construction shows that the Seiberg Witten curve dutifully factorizes in the limit, and confirms that each cusp corresponds to a weakly coupled generalized $SU(3)$ quiver built out of E_6 theories, bifundamental field and the occasional $SU(2)$ end-nodes, as discussed in the previous subsection.

Next we would like to conjecture a SW curve for generalized $SU(3)$ conformal quiver gauge theories with loops, the $\mathcal{T}_{(f_1, f_3), g}$. For inspiration we can use again the result of [6] for the solution for a close linear loop of unitary groups, which has $U(1)$ flavor symmetries only, and should be one of the weak coupling descriptions of $\mathcal{T}_{(f_1, 0), 1}$. For zero masses, the SW equation for the closed loop of n $SU(2)$ gauge groups is given simply as curve in $\mathbb{C} \times \mathbb{T}^2$, which we parameterize with coordinates v and z . The curve is defined by a degree 2 polynomial in v

$$v^3 = f_2(z)v + f_3(z) \quad (3.33)$$

The functions $f_{2,3}(z)$ are a meromorphic function on \mathbb{T}^2 , with simple poles at the n punctures $z = z_a$. The SW differential is again $v dz$. The space of couplings of the theory is the moduli space of a torus with n marked points. In the weak coupling limit, the gauge couplings are simply given as $\tau_a \sim z_{a+1} - z_a$. The sum of gauge couplings is the modular parameter of the torus. The space of possible $f_{2,3}(z)$ is $2n$ dimensional: constant shifts are allowed, but the sum of the residues of $f_{2,3}$ is zero, because the torus is compact.

The solution with mass deformations given in [6] involves the usual slight complication: morally, one would just set

$$v^2 = f_1(z)v^2 + f_2(z)v + f_3(z) \quad (3.34)$$

and identify the residues of f_1 , which coincide with the residues of λ , with the mass parameters of the theory, but the sum of the residues of f_1 is zero if f_1 is a standard meromorphic function, so one has to value v in some affine bundle. The shift of $v \rightarrow x + 1/2 f_1(t)$ which eliminates the linear term also eliminates the need of affine bundles, bringing us back to the form

$$x^3 = \phi_2(z)x + \phi_3(z) \quad (3.35)$$

Again we keep $\lambda = x dz$, as the shift produces a useful shift in the definition of the flavor charges. $\phi_2(z)$ is now allowed double poles at $z = z_a$, and $\phi_3(z)$ triple poles. As for the genus zero case, before the shift only one branch of $v(z)$ had a pole at $z = z_a$, hence after the shift the residues of the poles of λ on the three branches $x(z)$ must take the form $(2\tilde{m}_a, -\tilde{m}_a, -\tilde{m}_a)$. Alternatively, the discriminant

$$4\phi_2(z)^3 - 27\phi_3(z)^2 \quad (3.36)$$

is allowed poles of order at most 4.

By analogy with the case of open and closed linear quivers, we would to associate the ensemble of generalized quiver gauge theories with g loops, f_1 $U(1)$ flavor symmetry groups

and f_3 $SU(3)$ flavor symmetry groups $\mathcal{T}_{(f_1, f_3), g}$ with the canonical “rank 3” SW curve on a Riemann surface $C_{(f_1, f_3), g}$ of genus g and (f_1, f_3) punctures.

$$x^3 = \phi_2(z)x + \phi_3(z) \tag{3.37}$$

We will allow the quadratic differential to have simple poles at all punctures, and the cubic differential to have simple poles at the punctures of first type, double at the punctures of second type.

Mass deformations will appear as double poles for the quadratic differential, triple for the cubic differential. The two types of punctures are distinguished by the fact that at punctures of the first type the residues of λ on the three branches should be again of the form $(2\tilde{m}_a, -\tilde{m}_a, -\tilde{m}_a)$, i.e. the discriminant

$$4\phi_2(z)^3 - 27\phi_3(z)^2 \tag{3.38}$$

is allowed poles of order at most 4.

Notice that the linear space of quadratic differential with appropriate poles on a Riemann surface of genus g has $3g - 3 + f_1 + f_3$, as they are in one-to-one correspondence with the complex moduli of the Riemann surface itself. The space of cubic differentials with appropriate poles is of dimension $5g - 5 + f_1 + 2f_3$. The dimension of the Coulomb branch of the generalized quiver is correctly reproduced, as each puncture of the first type corresponds to an $U(1)$ factor in the flavor symmetry group, each puncture of the second type to a $SU(3)$ factor.

The possible degeneration limits of $C_{(f_1, f_3), g}$ to a collection of three-punctured spheres are again in perfect correspondence with the set of all possible generalized quivers with g loops and appropriate flavor groups.

3.3 An explicit construction from the A_2 (2, 0) six dimensional SCFT

In the case of $SU(3)$ quiver gauge theories, the brane construction involves three coincident M5 branes wrapping \mathbb{C}^* or \mathbb{T}^2 and the four-dimensional space-time.

We can immediately give a uniform definition of the $\mathcal{T}_{(f_1, f_3), g}$ theories: the four dimensional limit of the twisted A_2 (2, 0) six-dimensional field theory on a Riemann surface of genus g , in presence of $f_1 + f_3$ defect operators of appropriate type at the punctures, or equivalently on a non-compact Riemann surface of genus g with n infinite tubular regions and appropriate boundary conditions at the end of the tubes.

The A_2 theory has two protected operators, of R-charge 2 and 3 respectively, which after the twist become a quadratic and a cubic differential. We identify their expectation values with $\phi_{2,3}$. We will not try to define the defect operators in detail. Through our examples, we have specified the admissible poles for $\phi_{2,3}$ at the defects of the two types, and the flavor symmetries associated with the defects. We refer the reader to section 3 of [7] for a more detailed discussion of the relation between these defects and similar codimension 2 defects in 5d Young-Mills theory.

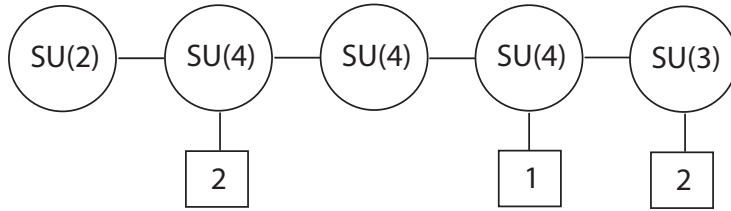

Figure 31: A conformal quiver of unitary gauge groups in the shape of an A_5 Dynkin diagram

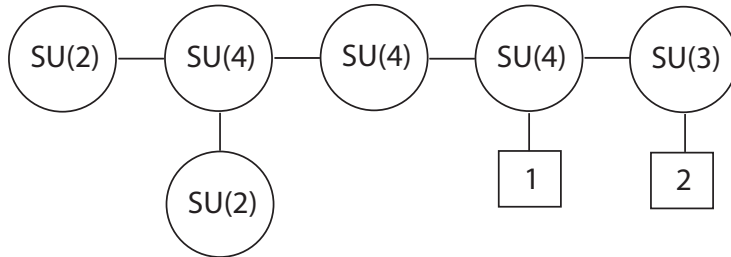

Figure 32: A conformal quiver of unitary gauge groups in the shape of an D_6 Dynkin diagram

4. $SU(N)$ generalized quivers

4.1 Intermission

Before we continue, it is useful to ask a simple question: what are the possible superconformal quivers with unitary gauge groups? If we denote with (n_i) the vector of ranks of the nodes, and (m_i) the number of fundamental flavors at the nodes, then the condition $N_f = 2N_c$ at each node can be written as $Cn = m$, where $C_{ij} = -1$ if the nodes i and j are contiguous, and $C_{ii} = 2$.

The graphs which admit a solution with positive non-zero n and non-negative m have been identified in [14] as ADE graphs (see fig. 31,32,33). The A type of quivers coincide with the linear quiver which are solved in [6]. The D types of quivers can be probably solved with similar methods, including orbifold fiveplanes planes in the brane construction. (See [14] for a similar three-dimensional construction). The E type quivers may lie outside our reach. It would be interesting to compute the Seiberg-Witten curve and differential for those.

We will meet another special class of superconformal quiver gauge theories. A linear quiver of unitary groups can be terminated by a symplectic group $USp(2n)$ at one or either ends (see fig. 34) [15]. The condition for conformal invariance of the $USp(2n)$ node is that it should be coupled to a total of $2n + 2$ fundamental flavors (we use a notation where m flavors of $USp(2n)$ have a $SO(2m)$ flavor symmetry). It is also possible to end a quiver of unitary groups by coupling to matter in an antisymmetric representation. This case could probably also be treated through the orientifold construction in [15].

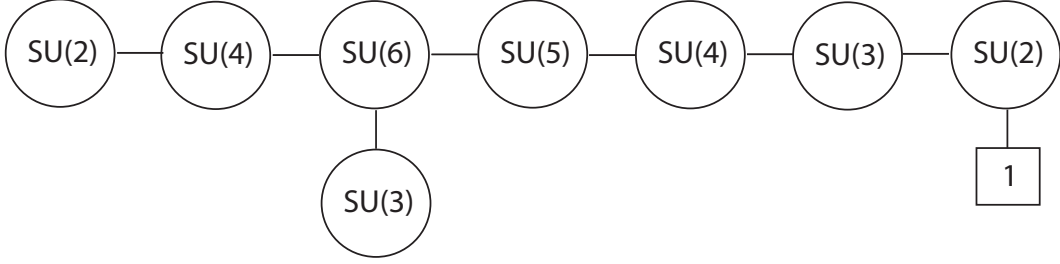

Figure 33: A conformal quiver of unitary gauge groups in the shape of an E_8 Dynkin diagram

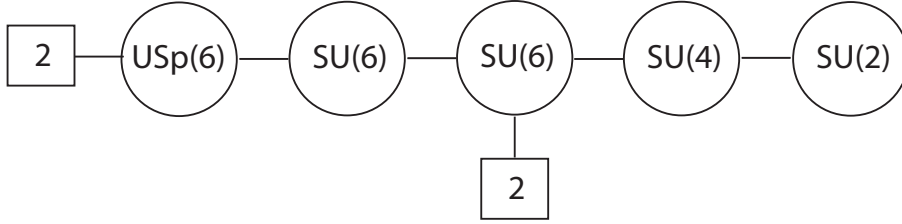

Figure 34: A conformal linear quiver of unitary gauge groups terminated by an USp gauge group. The two flavors at the USp node have a $SO(4) = SU(2) \times SU(2)$ flavor symmetry

4.2 Canonical form

In the $SU(N)$ case we do not have the guidance of S-duality or Argyres-Seiberg duality. We will need to immediately plunge in the analysis of examples of SW curves. We expect to find a structure akin to the $SU(2)$ and $SU(3)$ generalized quivers. For that reason, we will set up a convenient framework.

The canonical form for SW curves of generalized $SU(N)$ quivers will always be of the now familiar form: a curve in the cotangent bundle of a Riemann surface of genus g and n punctures, with canonical one form $x dz$ and

$$F(x, z) = x^N - \sum_{i=2}^N x^{N-i} \phi_i(z) \quad (4.1)$$

The $\phi_i(z) dz^i$ are degree i differentials with appropriate poles at the punctures.

There is a rich zoo of possible choices at the punctures. Without mass deformations, there are two extreme possibilities: simple poles for all ϕ_i , or poles of order up to $i - 1$ for ϕ_i . More general conditions are possible, labeled by the order $p_i < i$ of admissible poles for ϕ_i . As long as $p_i < i$, $x \sim (z - z_a)^{-c/q}$ at punctures, with $c < q$ both positive integers. If we write $(z - z_a) \sim w^q$ then λ has locally the form $w^{q-1-c} dw$ and has no poles at the puncture. In practice, we will soon find that the punctures we need have $c = q - 1$, hence λ is not forced to have zeroes either. Then the roots of x at z_a will come in groups of q_s $x \sim (z - z_a)^{\frac{1-q_s}{q_s}}$, and one possible labeling of the type of punctures will be the set of $q_s > 0$ such that $\sum_s q_s = N$.



Figure 35: Young tableaux labeling of $SU(2)$ punctures. Corresponding Newton polygon.
a) Absence of a puncture. $p_1 = 1 - 1 = 0$, $p_2 = 2 - 2 = 0$. Two equal mass parameters adding to zero.
b) Basic puncture: $p_1 = 1 - 1 = 0$, $p_2 = 2 - 1 = 1$. Mass parameters $(m, -m)$. $SU(2)$ flavor symmetry.

With mass deformations turned on, we take ϕ_i to have order i , so that λ has simple poles at the punctures. The N residues of λ at the puncture may not be all distinct, and we can require various groups of h_t identical residues. Thus we can consider a puncture labeled by a partition of $N = \sum_t h_t$. Our first task will be to find out which partitions h_t of N label mass deformations of which pole structures (p_i) and which partitions q_i , and which flavor symmetry group is associated with such puncture. Luckily, we will be able to find sufficient examples among superconformal linear quivers to derive the complete dictionary.

The simple answer is that if q_s are the lengths of rows of a Young Tableau of N boxes, then h_t are the height of the columns. The flavor symmetry is $S(\prod U(N_h))$, where N_h is the number of columns of height h . If we write the Young Tableaux with columns of height decreasing left to right, and rows of length increasing top to bottom, the numbers $i - p_i$ are monotonically non-decreasing, and correspond to the height of the $i - th$ box of the diagram (see fig. 35,36 and 37). The relation between the p_i and the q_s is easily understood through the Newton polygon.

The Newton polygon predicts the number of roots of x with given behavior at z_a in terms of the slopes of sides of the convex envelope of the p_i . The basic idea is to solve for x approximately by only considering terms in the polynomial for which p_i lie on a given side of the convex envelope. The approximate solution for x behaves like $(z - z_a)^{-1}$ to the power of the slope of that side. Every other term in the polynomial is a subleading correction to this approximation for $z \rightarrow z_a$. It can be easily shown that this method identifies all the roots of the polynomial.

From $i = 1$ up, the p_i grow with slope 1 except at the beginning of each row of the Young Tableau, where they remain constant for one step. Hence each row of length q_s of the Young Tableau corresponds to a side of the convex envelope, of slope $\frac{q_s - 1}{q_s}$.

As the case of $SU(2)$, $SU(3)$ quiver gauge theories, we can give a uniform definition of certain $\mathcal{T}_{(f_a),g}[A_{N-1}]$ theories: the four dimensional limit of the twisted A_{N-1} $(2,0)$ six-dimensional field theory on a Riemann surface of genus g , in presence of (f_a) defect operators of appropriate type at the punctures, or equivalently on a non-compact Riemann surface of genus g with n infinite tubular regions and appropriate boundary conditions at the end of the tubes. The A_{N-1} theory has $N - 1$ protected operators, of R-charge $i = 2 \cdots N$, which after the twist become differentials of degree i . We identify their expectation values with ϕ_i . We will not try to define the defect operators in detail, but we are satisfied

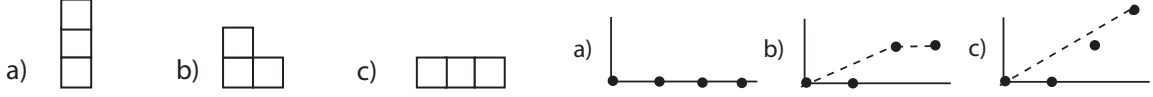

Figure 36: Young tableaux labeling of $SU(3)$ punctures. Corresponding Newton polygon.
a) Absence of a puncture. $p_i = i - i = 0$. Three equal mass parameters adding to zero.
b) Type 1 puncture: $p_1 = 1 - 1 = 0$, $p_2 = 2 - 1 = 1$, $p_3 = 3 - 2 = 1$. Mass parameters $(m, m, -2m)$. $S(U(1) \times U(1)) = U(1)$ flavor symmetry.
c) Type 2 puncture: $p_i = i - 1$. Generic mass parameters $(m_1, m_2, -m_1 - m_2)$. $SU(3)$ flavor symmetry

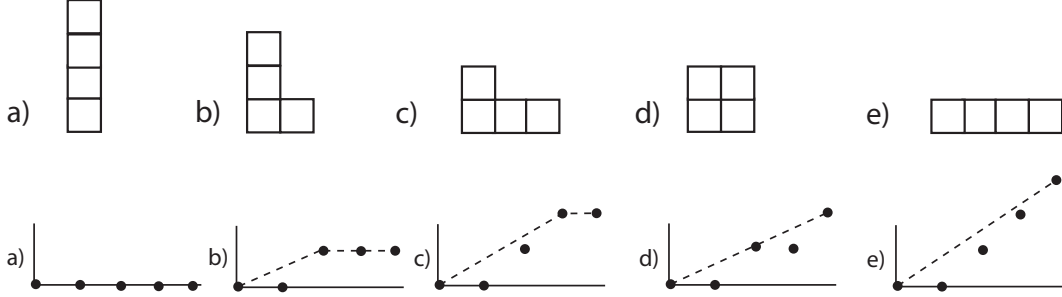

Figure 37: Yang tableaux labeling of $SU(4)$ punctures. Corresponding Newton polygon.
a) Absence of a puncture. $p_i = i - i = 0$. Four equal mass parameters adding to zero.
b) Basic puncture: $p_i = 1$. Mass parameters $(m, m, m, -3m)$. $S(U(1)^2) = U(1)$ flavor symmetry.
c) $p_1 = 1 - 1 = 0$, $p_2 = 2 - 1 = 1$, $p_3 = 3 - 1 = 2$, $p_4 = 4 - 2 = 2$. Mass parameters $(m_1, m_1, m_2, -2m_1 - m_2)$. $S(U(1) \times U(2))$ flavor symmetry.
d) $p_1 = 1 - 1 = 0$, $p_2 = 2 - 1 = 1$, $p_3 = 3 - 2 = 1$, $p_4 = 4 - 2 = 2$. Mass parameters $(m_1, m_1, -m_1, -m_1)$. $SU(2)$ flavor symmetry.
e) Full puncture: $p_i = i - 1$. Generic mass parameters $(m_1, m_2, m_3, -m_1 - m_2 - m_3)$. $SU(4)$ flavor symmetry

to have given the form of admissible singularities for ϕ_i at the defects of various types, and the flavor symmetries associated with the defects. We refer the reader to section 3 of [7] for a more detailed discussion of the relation between these defects and similar codimension 2 defects in 5d Young-Mills theory.

Because of the $N_f = 2N_c$ condition, general conformal linear quivers have a convex profile of gauge group ranks $2n_i - n_{i+1} - n_{i-1} = m_i$. From one end to the other, the ranks n_i grow up to a maximum value N , then decrease again. The Seiberg-Witten curve for such a quiver is associated to a sphere with several basic punctures $p_i = 1$ and two generic punctures, whose data encode the specific profile of the ranks n_i up to N at either end of the quiver. More precisely, the differences $n_{i+1} - n_i$ at the beginning of the quiver coincide with the lengths of the rows of the Young Tableaux for the first generic puncture. The differences $n_{i-1} - n_i$ at the end of the quiver coincide with the lengths of the rows of the Young Tableaux for the second generic puncture (see fig. 38 for all $N = 4$ cases).

We can build a quiver whose Seiberg-Witten curve is associated to a sphere with n basic $p_i = 1$ punctures only (see fig. 39). Its gauge coupling parameter space is $\mathcal{M}_{n,0}$, as

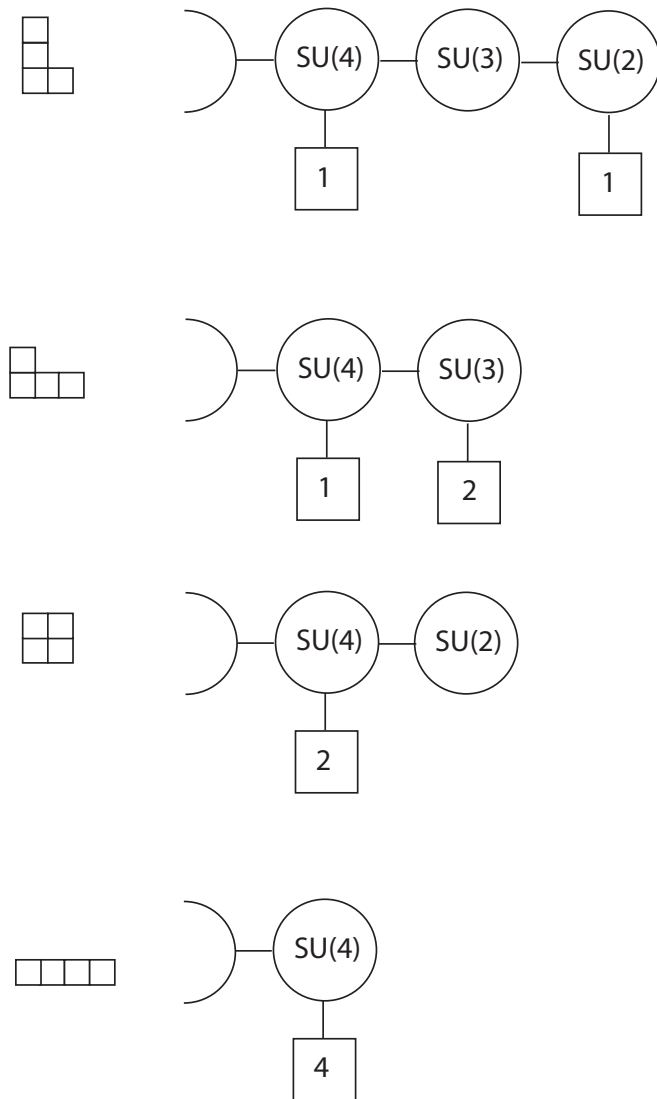

Figure 38: Different ways to end a conformal linear quiver of $SU(4)$ groups, and corresponding punctures.

all punctures are equivalent. This quiver has the largest possible S-duality group, because all punctures can be permuted among themselves. We can use this S-duality to learn a lot of useful information. For example the degeneration limit where two punctures $p_i = 1$ collide corresponds to the weak coupling limit of an $SU(2)$ gauge group, coupled to a single fundamental hypermultiplet and to the $SU(2)$ flavor symmetry of a puncture associated to the partition $N = (N - 2) + 1 + 1$.

A simple consequence is that $SU(N)$ with $N_f = 2N$ should enjoy a form of Argyres-Seiberg duality. Indeed the theory is associated to a sphere with two basic $p_i = 1$ punctures and two full $p_i = i - 1$ punctures (as for $N = 2, 3$ only a $U(1)^2 \times SU(N)^2$ subgroup of the flavor group is manifest). The usual weak coupling limit corresponds to the degeneration

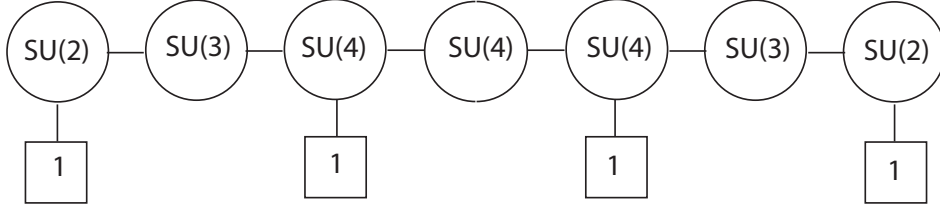

Figure 39: Linear conformal quiver associated to a sphere with 10 basic $p_i = 1$ punctures for $SU(4)$

of the sphere which brings two different types of punctures together. The very strongly coupled region corresponds to the limit where the two basic punctures collide. In that region, the theory must have a realization as a $SU(2)$ dual gauge theory coupled to a single fundamental hypermultiplet and to an interacting SCFT with $SU(2) \times SU(2N)$ flavor symmetry (no further enhancement is expected for $N > 3$).

More generally, the collision of $m < N - 1$ of the $p_i = 1$ punctures corresponds to the weak coupling limit of an $SU(m)$ gauge group, and leaves behind a puncture associated with the partition $N = (N - m) + 1 + 1 + \dots + 1$. We will call such partitions “L-shaped” Young Tableaux. The collision of $N - 1$ or more $p_i = 1$ punctures corresponds to the weak coupling limit of an $SU(N)$ gauge group, and leaves behind a full puncture $p_i = i - 1$. We can identify the behavior of this simple quiver theory at all strongly coupled cusps of moduli space, and see a dual weakly coupled description involving a generalized quiver, with special unitary gauge groups and several distinct building blocks, which are irreducible theories associated to three-punctures spheres with L-shaped Young Tableaux labeling the punctures. We can use decoupling limits to produce a general theory $\mathcal{T}_{(f_a),0}$ involving only L-shaped Young Tableaux at punctures, and we can gauge pairs of $SU(N)$ flavor symmetries at full punctures $p_i = i - 1$ to engineer $\mathcal{T}_{(f_a),g}$, again with L-shaped Young Tableaux only.

What about theories with more general Young Tableaux at the punctures? We have linear quivers representing theories with up to two general punctures. S-duality is not strong enough to predict the behavior at all cusps in parameter space, and there is no way to study the collision of the two generic punctures directly. Still, we can look carefully at the degeneration limit of the Seiberg-Witten curve, and hazard some educated guesses. We find a surprise. The dual weakly coupled gauge groups arising at the very strongly coupled region of the parameter space where the two generic punctures collide is typically $SU(N)$ or some other $SU(I)$ with $I < N$, but there is a special possibility: the collision of two punctures associated to Young Tableaux with two columns only. Then the decoupling gauge group appears to be a symplectic group, possibly coupled to some extra fundamentals. Among the examples, we see linear quivers of unitary groups, terminated by the symplectic group. See figures 40, 41, 42 for some nice examples. These quivers admit a brane realization involving O6 planes [15]. The M-theory lift should still involve the A_{N-1} theory on a sphere. The geometry of the O6 planes will lead to some appropriate defects. Our result indicates that the “O6 defect” leading to symplectic groups must coincide with



Figure 40: Left: a quiver associated to a sphere with 4 basic $p_i = 1$ punctures and two punctures labeled by Young Tableaux with two columns of height 2. The theory has a $U(1)^4 \times SU(2)^2$ natural flavor symmetry, actually enhanced to $U(1)^3 \times SU(4)$. Right: In the very strongly coupled limit where the two special punctures are closed together, an S-dual weakly coupled quiver emerges, with a USp gauge group. Notice that the $SU(4)$ flavor symmetry is realized as the $SO(6)$ flavor symmetry of the three fundamentals of $USp(4)$.

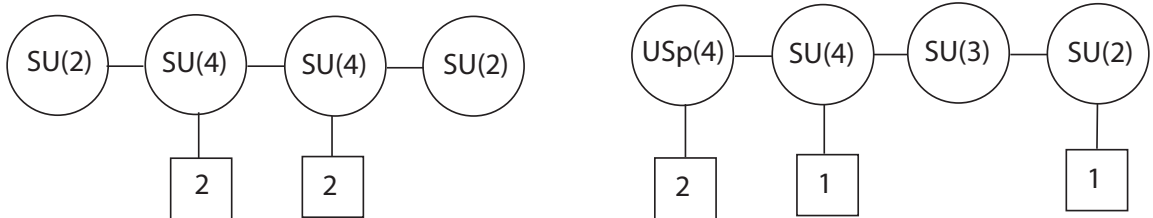

Figure 41: Another pair of S-dual quivers associated to a sphere with 5 basic $p_i = 1$ punctures and two punctures labeled by Young Tableaux with two columns of height 2.

a pair of standard defects with two columns.

The educated guess on the decoupling gauge group gives us a good control on the cusps in parameter space for general linear quiver gauge theories. Through decoupling limits, we can enlarge further the set of irreducible SCFTs corresponding to three punctured spheres which admit a direct construction, and can be used as elementary building blocks for generalized quivers. Unfortunately, not all conceivable theories associated to several punctures of generic type can be constructed from decoupling limits of linear quiver gauge theories. Clearly we can start with a general linear quiver, and produce theories associated with two general punctures, and one or more L-shaped Young Tableaux. On the other hand we expect that an interacting SCFTs should exist, associated to spheres with three punctures labeled by any three Young Tableaux with N boxes. A six-dimensional construction involving the compactification of the $A_{N-1}(2,0)$ theory on the three-punctured sphere gives us a definition, but we would prefer a purely four dimensional construction. There are indications that an alternative construction may lie in a rich network of RG flows between such theories, initiated by expectation values in appropriate Higgs branches. We will not pursue this idea further in this paper.

The “unconstructible” theories are a finite minority for each given N . Most theories admit a realization as generalized quivers of simpler building blocks. There is an elementary building block that really stands out of the crowd. It is a $SU(N)$ generalization of the

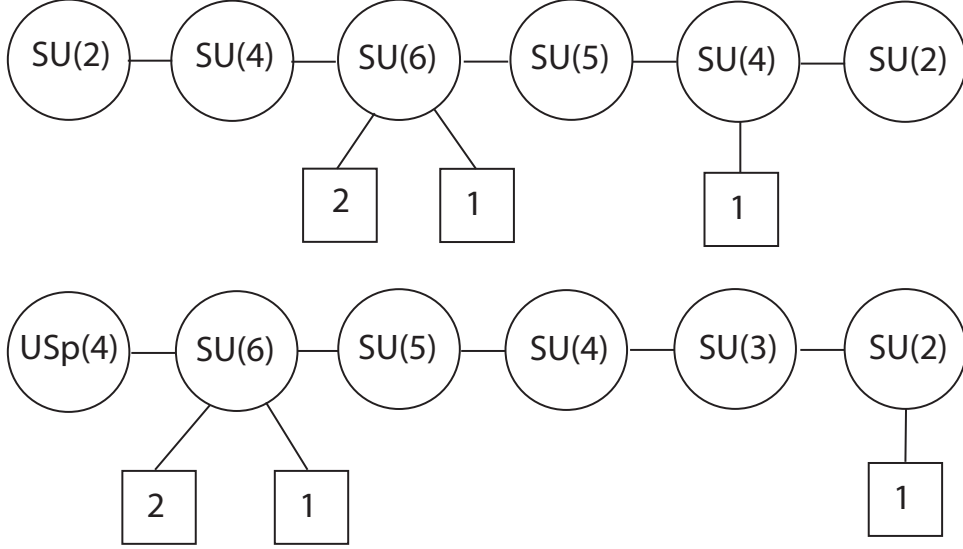

Figure 42: A third example of S-dual quivers, associated to a sphere with 7 basic $p_i = 1$ punctures, one puncture labeled by a Yang Tableau with two columns of height 3, one puncture labeled by a Yang Tableau with a column of height 4, one of height 2

theory four hypers for $SU(2)$, or the E_6 theory for $SU(3)$: an interacting SCFT with three $SU(N)$ flavor symmetry groups which, when gauged, provide half the amount of matter needed by a conformal $SU(N)$ gauge theory. This theory is associated to a sphere with three full $p_i = i - 1$ punctures. We will simply denote it as $T[A_{N-1}]$. We can build it from the linear quiver with $3(N - 1)$ basic $p_i = 1$ punctures, in the limit where three groups of $N - 1$ punctures collapse. (see fig. 43 for an $SU(4)$ example)

Starting from $2g - 2$ $T[A_{N-1}]$ theories and gauging $3g - 3$ pairs of $SU(N)$ flavor symmetry groups we can define a $\mathcal{T}_g[A_{N-1}]$ theory which we associate to a Riemann surface of genus g . We identify this theory as the theory of N M5 branes (or better, the twisted $A_{N-1} (2, 0)$ theory) wrapping a Riemann surface of genus g .

4.3 The linear quivers

In the formalism of [6], $SU(N)$ with $N_f = 2N$ has a SW curve of the form

$$v^N t^2 + c_1(v^N - u^{(2)}v^{N-2} - u^{(3)}v^{N-3} \dots - u^{(N)})t + c_2 v^N \quad (4.2)$$

and SW differential $\lambda = v \frac{dt}{t}$. The usual manipulations lead us to

$$x^N = \sum_{d=2}^N \frac{u^{(d)}}{(t-1)(t-t_1)t^{d-1}} x^{N-d} \quad (4.3)$$

We see that ϕ_i have simple poles at the $t = 1, t_1$ punctures, and poles of order $i - 1$ at the $t = 0, \infty$ punctures. Remember that the brane construction only makes a $U(N) \times U(N)$ subgroup of the full flavor symmetry group manifest. Following the example of the $SU(2)$, $SU(3)$ case, we would like to associate the punctures at $t = 1, t_1$ with the two

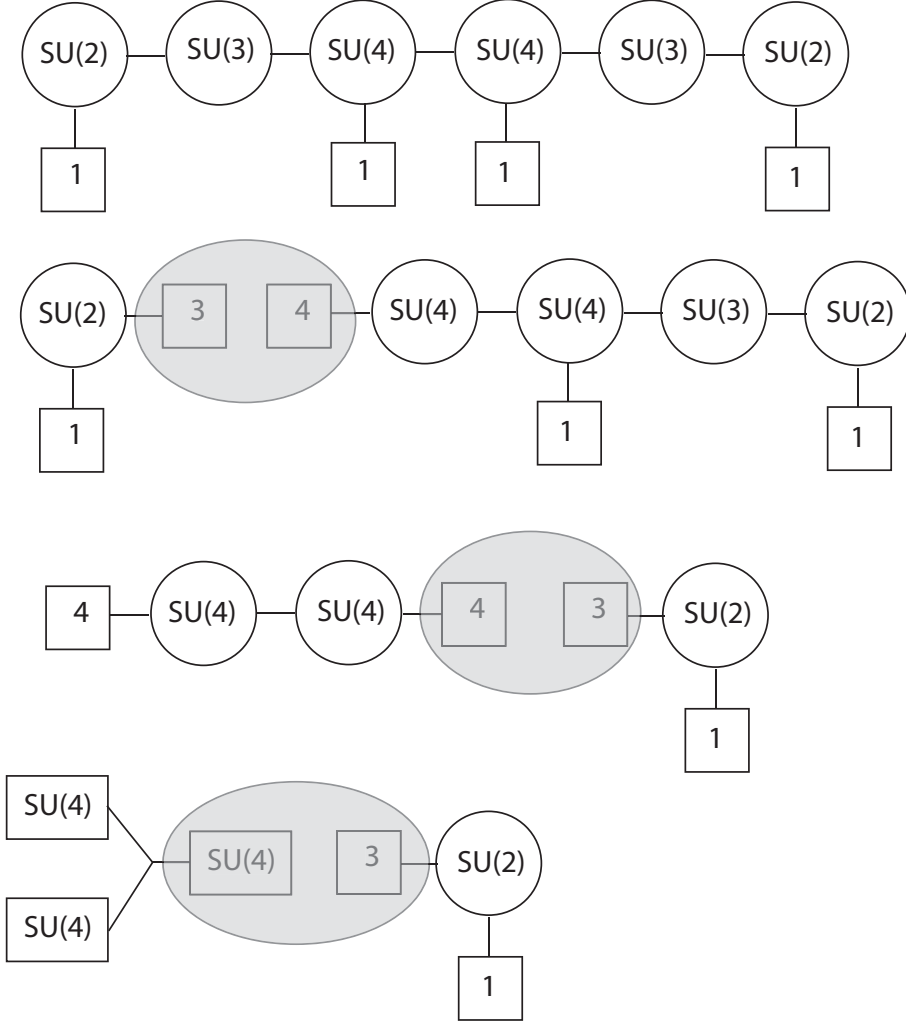

Figure 43: The construction of $T[A_3]$ from the linear quiver associated to the sphere with 9 basic punctures.

Collision of three punctures decouples an $SU(3)$ gauge group, coupled to a $SU(2)$ $N_f = 4$ theory and to the rest of the quiver.

Collision of three more punctures decouples a second $SU(3)$ gauge group, coupled to a $SU(2)$ $N_f = 4$ theory and to the rest of the quiver.

Collision of the last three punctures happen in a very strongly coupled cusp of the original quiver, and must decouple a third $SU(3)$ gauge group, coupled to a $SU(2)$ $N_f = 4$ theory and to a $SU(3)$ subgroup of a $SU(4)$ flavor group of $T[A_3]$.

$U(1)$ factors, and the punctures at $t = 0, \infty$ with the $SU(N)$ factors. We can verify the identification through the mass deformed curve. The mass-deformed curve is given as a general polynomial of degree N in v and 2 in t .

$$(t-1)(t-t_1)v^N = M_2(t)v^{N-1} + \sum_{d=2}^N P_2^{(i)}(t)v^{N-i} \quad (4.4)$$

The equation can be brought to the canonical form by usual shift of v to remove the coefficient of v^{N-1} , and map to coordinates (x, z) .

At the punctures $t = 1, t_1$ in the original curve, λ has a pole on a single branch of $v(t)$. The residue is identified with the mass parameter of a $U(1)$ factor. After the shift of v , the residues of λ at $t = 1, t_1$ on the N branches of $x(z)dz$ take the form $((N-1)m, -m, \dots, -m)$. We conclude that a puncture with all $p_i = 1$ has a mass deformation associated to the partition of $N = (N-1) + 1$ and $U(1)$ flavor symmetry. On the other hand the limiting values of v at $t = 0, \infty$ were generic. After the shift the residues of λ at t zero or infinity take a generic form $(\sum m_a, -m_1, -m_2, \dots, -m_{N-1})$ and are identified with the mass parameters of an $SU(N)$ factor of the flavor symmetry group. We learn that a puncture with $p_i = i - 1$ is associated to the partition of $N = 1 + 1 \dots 1$, and a $SU(N)$ flavor symmetry.

We do not gain much by considering a simple linear quiver of n $SU(N)$ gauge groups with N fundamentals at each end. The SW curve of the theory is associated to a sphere with $n+1$ punctures of the $p_i = 1$ type, and 2 of the $p_i = i-1$ type. Both the mass deformed SW curve and the flavor symmetry group $SU(N)^2 \times U(1)^{n+1}$ confirm the conclusions of the $SU(N)$ $N_f = 2N$ analysis. We gain more insight from a linear conformal quiver associated to a sphere with $n+3$ identical, simple punctures. The quiver has gauge groups, in order, $SU(2) \times SU(3) \times SU(4) \dots SU(N)^{n-2N+4} \dots SU(4) \times SU(3) \times SU(2)$. Conformal symmetry requires a fundamental hypermultiplet at the $SU(2)$ nodes and at the first and last $SU(N)$ node. This quiver has the desired $U(1)^{n+3}$ flavor symmetry. The SW curve for such a quiver is described in [6]. It can be written as

$$\begin{aligned}
& v^N t^{n+1} + c_1 v^{N-2} (v^2 - u_1^{(2)}) t^n + c_2 v^{N-3} (v^3 - u_2^{(2)} v - u_2^{(3)}) t^{n-1} + \dots \\
& + c_{N-1} (v^N - u_{N-1}^{(2)} v^{N-2} - \dots - u_{N-1}^{(N)}) + \dots \\
& + c_{n-N+2} (v^N - u_{n-N+2}^{(2)} v^{N-2} - \dots - u_{n-N+2}^{(N)}) + \dots \\
& + c_{n-1} v^{N-3} (v^3 - u_{n-1}^{(2)} v - u_{n-1}^{(3)}) t^2 + c_n v^{N-2} (v^2 - u_n^{(2)}) t + c_{n+1} v^N = 0
\end{aligned} \tag{4.5}$$

with the usual SW differential. We can collect the same powers of $v = tx$ to get

$$\prod_{a=0}^n (t - t_a) t x^N = \sum_{i=2}^N U_{n+3-2i}^{(i)}(t) x^{N-i} \tag{4.6}$$

All the differentials of various degrees have simple poles at all $n+3$ punctures $0, \dots, t_a, \dots, \infty$. This indicates that the theory has a large S-duality group, similar to the one for $SU(2)$ linear quivers, which can permute the punctures freely. The correct gauge coupling parameter space of this theory should be $\mathcal{M}_{n+3,0}$. We can use a fractional linear transformation to put all punctures on the same footing.

$$\Delta_{n+3}(t) x^N = U_{n-1}^{(2)}(t) x^{N-2} + U_{n-3}^{(3)}(t) x^{N-3} + \dots + U_{n+3-2N}^{(N)} \tag{4.7}$$

The mass deformation of the curve takes the form

$$\begin{aligned}
& (v - m_1)(v - m_2)^{N-1}t^{n+1} + c_1(v - m_2)^{N-2}(v^2 + \dots)t^n + \\
& + c_2(v - m_2)^{N-3}(v^3 + \dots)t^{n-1} + \dots + c_{N-1}(v^N + \dots) + \dots \\
& c_{n-N+2}(v^N + \dots) + \dots c_{n-1}(v - m_3)^{N-3}(v^3 + \dots)t^2 + \\
& + c_n(v - m_3)^{N-2}(v^2 + \dots)t + c_{n+1}(v - m_3)^{N-1}(v - m_4) = 0
\end{aligned} \tag{4.8}$$

The form of the curve is quite forbidding, but what matters is the pattern of $(v - m_a)$ factors at the beginning and at the end of the polynomial. We have seen a similar pattern in the $SU(3)$ case. That pattern has a very simple meaning. It is necessary and sufficient to insure that the asymptotic behavior of the N branches of $v(t)$ at $t = 0$ is $(m_4 + O(t), m_3 + O(t), m_3 + O(t), m_3 + O(t) \dots, m_3 + O(t))$ and similarly at $t = \infty$. This means that the SW differential λ has simple poles at all $n+3$ punctures $t = 0, \dots, t_a, \dots, \infty$, and that after the usual shift of v , the residues of λ take the expected form $((N-1)\tilde{m}_a, -\tilde{m}_a, \dots, -\tilde{m}_a)$. All punctures have $p_i = 1$ and $U(1)$ flavor symmetry.

We can also produce linear quivers with $n+2$ punctures of this simple type, and one completely general. The idea is to tweak one of the ‘‘tails’’ of the basic quiver, to get a more general gauge group $SU(n_1) \times SU(n_2) \times SU(n_3) \dots \times SU(n_k) \times SU(N)^{n-k-N+2} \dots SU(4) \times SU(3) \times SU(2)$. The quiver requires $F_i = 2n_i - n_{i-1} - n_{i+1}$ flavors at the $SU(n_i)$ node for conformal invariance, and $N - n_k$ at the first $SU(N)$ node. Here we assume $n_i < N$ and $2n_i \geq n_{i-1} + n_{i+1}$. It is useful to associate the rows of a Young Tableaux of N boxes to the nonincreasing sequence of positive numbers $q_i = n_{i+1} - n_i$. Notice that $\sum q_i = N$.

The curve from [6] takes the intuitive form

$$\begin{aligned}
& v^N t^{n+1} + c_1 v^{N-n_1} (v^{n_1} - u_1^{(2)} v^{n_1-2} + \dots + u_1^{(n_1)}) t^n + \\
& + c_2 v^{N-n_2} (v^{n_2} - u_1^{(2)} v^{n_2-2} + \dots + u_1^{(n_2)}) t^{n-1} + \dots c_{k+1} (v^N - u_{k+1}^{(2)} v^{N-2} - \dots - u_{k+1}^{(N)}) + \dots \\
& + c_{n-N+2} (v^N - u_{n-N+2}^{(2)} v^{N-2} - \dots - u_{n-N+2}^{(N)}) + \dots \\
& + c_{n-1} v^{N-3} (v^3 - u_{n-1}^{(2)} v - u_{n-1}^{(3)}) t^2 + c_n v^{N-2} (v^2 - u_n^{(2)}) t + c_{n+1} v^N = 0
\end{aligned} \tag{4.9}$$

We can collect the same power of v . The structure of the v factors implies that the coefficient of v^{N-i} has degree $d_i = n+1-s$ in t if and only if $i \leq n_s$ and $i > n_{s-1}$. The coefficient contains a factor of t^{i-1}

$$\prod_{a=0}^n (t - t_a) t^N x^N = \sum_{i=2}^N U_{d_i-i+1}^{(i)}(t) t^{N-i+i-1} x^{N-i} \tag{4.10}$$

We can erase a common t^{N-1} factor. We see that ϕ_i has a simple pole at all $t = 0, \dots, t_a$, but a pole of order $p_i = d_i - i + 1 - n - 2 + 2i = d_i + i - n - 1 = i - s$ at $t = \infty$ if and only if $i \leq n_s$ and $i > n_{s-1}$. In other words, there are $L_s = n_{s+1} - n_s$ p_i with value $i - 1 - s$. The string of numbers $i - p_i$ is just the height of the i -th box in the Young Tableaux.

Now we can introduce mass deformations, following [6].

$$\begin{aligned}
& \prod_s (v - m_s)^{l_s} t^{n+1} + c_1 \prod_s (v - m_s)^{l_s-1} (v^{n_1} + \dots) t^n + \\
& + c_2 \prod_{s|s>1} (v - m_s)^{l_s-2} (v^{n_2} + \dots) t^{n-1} + c_3 \prod_{s|s>2} (v - m_s)^{l_s-3} (v^{n_3} + \dots) t^{n-2} + \dots \\
& + c_{k+1} (v^N + \dots) + \dots + c_{n-N+2} (v^N + \dots) + \dots \\
& + c_{n-1} (v - \tilde{m}_1)^{N-3} (v^3 + \dots) t^2 + c_n (v - \tilde{m}_1)^{N-2} (v^2 + \dots) t + c_{n+1} (v - \tilde{m}_1)^{N-1} (v - \tilde{m}_2) = 0
\end{aligned} \tag{4.11}$$

The powers l_s are such that

$$\sum_{s|l_s>r-1} (l_s - r) = N - n_r \tag{4.12}$$

It is easy to verify that the l_s are the lengths of columns of the Young Tableaux whose rows are q_r . We recognize that the mass deformed puncture at infinity corresponds to the partition $N = \sum l_s$. As a final check, we see from the linear quiver that a whole $S(\prod U(F_i))$ factor of the flavor symmetry group should be associated to this puncture, as the other punctures only account for the mass parameters of $n + 2$ $U(1)$ gauge groups.

We found that we need to consider in general punctures labeled by a Young Tableaux of N boxes, from which we can read the admissible poles of ϕ_i at the puncture, the structure of the mass-deformed puncture and the flavor symmetry factors associated to that puncture. Notice that each $SU(F_i)$ factor of the flavor group, if weakly gauged, would have n_i flavors. n_i is strictly bigger than F_i , with a single exception. Only the “largest” type of puncture with $p_i = i - 1$ has an $SU(N)$ flavor symmetry which would contribute to an $SU(N)$ beta function the same way as N flavors.

4.4 Degeneration limits

It is easy to see that linear quivers with two generic tails are associated to a sphere with two generic punctures and several basic ones. Can we produce theories associated to a sphere with several generic punctures? We can surely write down a tentative Seiberg-Witten curve for the theory, starting from degree i differentials with appropriate p_i poles at each puncture. Following the example of the $SU(2)$ and $SU(3)$ cases, we can use the brane construction for the linear quiver examples to argue that the $A_{N-1} (2, 0)$ theory possesses codimension two defect operators associated with all possible types of punctures. Then we can consider the twisted compactification of the A_{N-1} theory on the Riemann surface, in the presence of appropriate defect operators at all punctures.

We would like to accomplish two goals from a purely four dimensional point of view: determine the nature of the “very strongly coupled regions” of moduli space of familiar theories, possibly in terms of generalized quivers, and characterize the ensemble of generalized quivers which corresponds to S-dual frames of the same theory. What happens when punctures collide? The linear quivers we have available can only tell us what happens when a generic puncture collide with a $p_i = 1$ basic puncture. Up to S-duality, we can always pick the basic puncture at t_n as the one colliding with the puncture at infinity. This makes the gauge coupling at the last $SU(n_1)$ node of the quiver very weak.

After decoupling, the differences $n_i - n_{i-1}$ are unchanged, except at the last node of the quiver. The new Young Tableaux has rows of the same length as the one for the original quiver, except that the two longest rows, of length n_1 and $n_2 - n_1$, have been combined into a single row of length n_2 . Correspondingly, the degree p_i of the poles of the differentials ϕ_i increases by one, except for $i \leq n_1$, where it stays $i - 1$. The result is unsurprising: if a pole of order p_i and a pole of order 1 are brought together naively, the resulting pole will have degree $p_i + 1$. The first n_1 differentials had $p_i = i - 1$, and after the collision they have poles of degree $p_i = i$. The coefficients of the poles are naturally associated to the u_i parameters of the decoupling $SU(n_1)$ gauge group, which become mass parameters after decoupling. This covers essentially all degeneration limits of a linear quiver with zero or one generic punctures. It will be quite harder to determine the result of a collision between generic punctures, which is really needed to understand the very strongly coupled region of general conformal linear quivers where the two generic punctures collide.

Lets start with the simplest theory of rank N , with $n + 3$ simple punctures on the sphere. The gauge coupling parameter space is the moduli space of $n + 3$ points on the sphere, and has boundaries where $k + 2$ punctures come together, or better, the sphere develops a nodal singularity, separating two spheres with, say, $k + 3$ punctures and $n - k + 2$ ones, joined at a puncture. Lets assume that $k + 3 \leq n - k + 2$. Again, without loss of generality, we can assume that the punctures are the t_a for $a \leq k$. In that case, the gauge coupling of the $k + 1$ -th node of the linear quiver is becoming very weak. We can distinguish several possibilities. If $k + 2 > N$, the gauge group is just an $SU(N)$. The quiver gauge theory decomposes into two superconformal linear quivers with the general structure $SU(2) - SU(3) - \dots - SU(N) - SU(N) - \dots - SU(N)$. These are associated respectively to a sphere with $k + 2$ basic punctures and one full one, and a sphere with $n - k + 1$ basic punctures and a full one.

Hence if more than N basic punctures come together, the simple picture where a sphere degenerates into two spheres, as a long tube pinches off and is replaced by two new full $p_i = i - 1$ punctures, works well. This is a very natural result. Both fragments are still associated with rank N theories, and have a full puncture with a $SU(N)$ flavor symmetry. The anomaly for the flavor symmetry is such that, when gauged, contributes to half of the amount of matter needed for a conformal $SU(N)$ gauge theory. This simple picture needs a refinement for collisions involving N or fewer basic punctures.

If we bring together N punctures, the gauge group which decouples is the first $SU(N)$ gauge group of the quiver. The theory decomposes into three pieces: a long linear quiver with gauge groups $SU(2) - SU(3) - \dots - SU(N) - SU(N) - \dots - SU(N)$, a “triangular” quiver with gauge groups $SU(2) - SU(3) - \dots - SU(N - 1)$ and a single fundamental hypermultiplet for the $SU(N)$ gauge group. The long quiver, as usual, is a rank N theory associated to a sphere with $n - N + 5$ simple punctures and a full one. From the punctured sphere picture, we would have expected to see a second theory appear, associated to a sphere with N basic punctures and a full one. This tentative theory has a bit of a problem: a nonzero degree i differential on the sphere must have poles of a total degree $2i$. N simple punctures and a full one give poles of total degree $2N - 1$ for ϕ_N , hence in general the last coefficient of the defining polynomial $x^N - \sum x^{N-i} \phi_i = 0$ is zero and the SW curve

simplifies to the curve for a rank $N - 1$ theory. The resulting rank $N - 1$ curve, with N basic punctures and a single full puncture indeed coincides with the curve for the triangular quiver with gauge groups $SU(2) - SU(3) - \dots - SU(N - 1)$. It is a bit harder to “see” the fundamental hypermultiplet. If we turn on mass parameters for the $SU(N)$ flavor symmetry group, ϕ_N can be non-zero, as the total degree of the poles for ϕ_N raises to $2N$. The SW curve does not factorize anymore, and appears very different from the mass-deformed rank $N - 1$ SW curve for the triangular quiver. Inspection of specific, simple examples for low N show that the two SW curves actually coincide, but the map between the two mixes the coordinates x, t on the base and the fibre of $T^*\mathbb{CP}^1$. It is interesting that the rank N realization of the theory makes the $SU(N)$ flavor symmetry group of the quiver manifest, while it would appear as an accidental enhancement in the rank $N - 1$ realization, which has a full puncture with naive flavor symmetry $SU(N - 1)$ and N simple punctures.

If we bring together $N - 1$ punctures, a $SU(N - 1)$ gauge group becomes weakly coupled. The main part of the quiver still terminates on a $SU(N)$ group with N flavors and a full $SU(N)$ flavor symmetry, of which a $SU(N - 1)$ subgroup is weakly coupled. The remaining gauge groups form a triangular quiver of gauge nodes $SU(2) - SU(3) - \dots - SU(N - 2)$. Now if mass parameters are absent, both ϕ_N and ϕ_{N-1} must be zero, because $N - 1$ simple punctures and a full one still cannot provide poles of sufficiently high overall rank. The SW curve simplifies to a rank $N - 2$ one. Even if one allows for mass parameters for the $SU(N - 1)$ flavor symmetry, ϕ_N still has to be zero, and we find again the rank $N - 1$ realization of the rank $N - 2$ triangular quiver.

Finally, if we bring together $k + 2 < N - 1$ punctures, a $SU(k + 2)$ gauge group becomes weakly coupled. The main part of the quiver terminates on a $SU(k + 3)$ group with $k + 2$ fundamental flavors. If we bring together $k + 2$ basic punctures we expect to find poles of degree up to a maximum of $k + 2$ for the ϕ_i . Indeed the big fragment of the linear quiver is associated to a sphere with $n - k + 1$ basic punctures and one with $p_i = \min(i - 1, k)$, and an L-shaped Young Tableaux. The remaining gauge groups form a triangular quiver of gauge nodes $SU(2) - SU(3) - \dots - SU(k + 1)$. Indeed if mass parameters are absent, the SW curve simplifies to a rank $k + 1$ one.

Now we are in position to explore any cusp in the gauge coupling parameter space, where the sphere factorizes into a generic tree of three-punctured spheres. The nodes between spheres are associated to weakly coupled $SU(k + 2)$ gauge groups with k up to $N - 2$. Each node splits the sphere into a sphere with $k + 3$ punctures and one with $n - k + 2$ punctures for some $k + 3 \leq n - k + 2$, and is assigned a $SU(k + 2)$ gauge group if $k + 2 < N$, $SU(N)$ otherwise. If $k + 2 = N$ the $SU(N)$ gauge group is coupled to an extra fundamental hypermultiplet.

Correspondingly, each three-punctured sphere will have punctures with $p_i = \min(i - 1, k_a)$, $a = 1, 2, 3$. The corresponding theory has rank $\min((k_1 + k_2 + k_3)/2, N)$ (or $\min((k_1 + k_2 + k_3 - 1)/2, N)$, whatever is integer), as the differentials of higher degree are necessarily zero. If one of the punctures is basic, say $k_3 = 1$, comparison with the linear quiver identifies the theory as a set of free hypermultiplets for $SU(k_1) \times SU(k_2)$. Otherwise, the theory is an interacting SCFT, with a non-trivial Coulomb branch and flavor symmetry

$U(k_1) \times U(k_2) \times U(k_3)$.

Notice that the anomaly for the $SU(k_3)$ flavor currents of such a theory is typically the same as the anomaly of $k_3 + 1$ fundamentals of $SU(k_3)$. Indeed the theory can be produced as the degeneration limit of a linear quiver with one puncture $p_i = \min(i - 1, k_a)$ and $k_1 + k_2$ basic punctures. If $k_1 + k_2 > k_3 + 1$, $SU(k_3)$ is the flavor symmetry of k_3 fundamentals of $SU(k_3 + 1)$. The anomaly is unaffected by the degeneration limit. Hence two “typical” theories cannot be coupled together by a conformal invariant $SU(k)$ gauge group. We saw two exceptions to this obstruction. If $k_1 + k_2 = k_3$, the theory has rank k_3 , and can be produced as the degeneration of a quiver with a full puncture of $SU(k_3)$ flavor symmetry and $k_1 + k_2 = k_3$ basic punctures. This is a triangular quiver of gauge groups $SU(2) \times SU(3) \times \cdots \times SU(k_3 - 1)$, with k_3 fundamentals at the $SU(k_3 - 1)$ node. The currents for the $SU(k_3)$ flavor symmetry of the triangular quiver have the anomaly of $k_3 - 1$ fundamentals of $SU(k_3)$ only. That must also be the anomaly of the $SU(k_3)$ flavor currents for the three-sphere theory with $k_1 + k_2 = k_3$. This allows a conformal $SU(k_3)$ coupling to a theory with the anomaly of $k_3 + 1$ fundamentals of $SU(k_3)$. A second exception are full $SU(N)$ punctures, which have the anomaly of N fundamentals of $SU(N)$, and can always be coupled pairwise.

The tree will have a “core” of three-spheres connected by $SU(N)$ gauge groups, which gauge the flavor symmetries of pairs of full punctures, each contributing half of the required beta function for conformality. Outer branches of the tree are connected by $SU(k)$, $k < N$ gauge groups, and the beta function receives a contribution proportional to $k - 1$ from the puncture on the side of the tree core, and $k + 1$ from the puncture on the outer side. They must be made by three spheres with $k_3 = k_1 + k_2$ only. Clearly, starting from the linear quiver with basic punctures and colliding them, one can generate a rank N theory with an arbitrary punctures $p_i = \min(i - 1, k_a)$, corresponding to L-shaped Young Tableaux. The degeneration limits of such a theory involves the same building blocks as above. Further gauging pairs of $SU(N)$ flavor symmetries leads to theories which are naturally associated to Riemann surfaces of higher genus, with punctures labeled by L-shaped Young Tableaux.

Out of this crowd of building blocks, a special role is clearly played by the theory with three full punctures of flavor symmetry $SU(N)$ on the sphere. It is relatively easy to “build” this crucial theory. Consider the linear quiver theory with $3N - 3$ punctures of the $p_i = 1$ type, gauge group $SU(2) \times SU(3) \cdots SU(N - 1) \times SU(N)^{N-2} \times SU(N - 1) \times SU(N - 2) \cdots SU(2)$. If we bring $N - 1$ punctures together, we know that we can work in a duality frame where a $SU(N - 1)$ gauge group is becoming weakly coupled, splitting the quiver into a triangular $SU(2) \times SU(3) \cdots \times SU(N - 2)$ and the main part of the quiver with $2N - 2$ gauge groups $SU(N)^{N-2} \times SU(N - 1) \times SU(N - 2) \cdots SU(2)$. This remaining quiver has one puncture with $SU(N)$ flavor symmetry and $2N - 2$ with $p_i = 1$. Next we can bring together other $N - 1$ basic punctures. Again, there is a duality frame in which the other $SU(N - 1)$ gauge group becomes weakly coupled, another triangular quiver decouples, and leaves behind a chain of $N - 2$ $SU(N)$ groups. This quiver has two punctures with $SU(N)$ flavor symmetry, and $N - 1$ $p_i = 1$ punctures. Finally, we can bring these $N - 1$ punctures together. By symmetry, we know that another hidden $SU(N - 1)$ must become weakly coupled in this degeneration limit. This group must be coupled to a

triangular quiver $SU(2) \times SU(3) \cdots \times SU(N-2)$, and to a $SU(N-1)$ subgroup of one of the three $SU(N)$ flavor groups of the interacting SCFT we are after. We will denote this special SCFT as \mathcal{T}_N . If we place a puncture at $t = 0$, one at $t = \infty$, T_N has a SW curve

$$x^N = \sum_{i=3}^N \frac{P_{i-3}(t)}{t^{i-1}(t-1)^{i-1}} \quad (4.13)$$

Now we can follow the example of $SU(2)$ and $SU(3)$ theories, and define simple theories associated to Riemann surfaces of genus g and n punctures with $SU(N)$ flavor symmetry, as a generalized quiver of g loops whose matter consists of an appropriate number of the \mathcal{T}_N theories. We can naturally identify such generalized quiver gauge theories with the twisted compactification of the $A_{N-1}(2,0)$ theory on the Riemann surface, possibly in the presence of appropriate defect operators or semi-infinite tubes. All possible degeneration limits in the moduli space $\mathcal{M}_{n,g}$ will reduce to an appropriate generalized quiver of T_N theories, with g loops and n $SU(N)$ flavor groups. Of course we would like to build theories associated with Riemann surfaces and punctures of a general type, and give a generalized quiver description of all possible degeneration limits of the gauge coupling moduli space.

What is the result of a degeneration limit which brings two generic punctures of degrees p_i, p'_i together? The first question to ask is which gauge group may become weakly coupled in the limit. The three punctured sphere will have the original two punctures, and a third one. Remember that a degree i differential must have poles of a total degree $2i$ on the sphere. Whenever $p_i + p'_i < i$, even if the third puncture is a full puncture, with mass parameters turned on, the i -th differential ϕ_i will have to be zero. Out of the naive mass parameters for the full puncture at infinity, the dimension i combination can be turned on only if $p_i + p'_i \geq i$. If $p_i + p'_i > i$ and we turn off the mass parameters, $\phi_i = \frac{P_{p_i+p'_i-i-1}}{t^{p_i}(t-1)^{p'_i}}$ and the Coulomb branch has $p_i + p'_i - i$ operators of dimension i .

From the point of view of the remaining Riemann surface, the differentials ϕ_i have naive degree $p_i + p'_i$. Turning off the Coulomb branch parameters of the theory associated to the three-punctured sphere naturally reduces that degree to $\min(p_i + p'_i, i)$. Again, for each $p_i + p'_i \geq i$ the coefficient of the degree i pole is the degree i combination of the mass parameters for the flavor symmetry group. These mass parameters should be identified with the Coulomb branch fields for the decoupling gauge group.

Everything would be clear if $p_i + p'_i \geq i$ were true for all $i \leq I$. Then we would just conclude that an $SU(I)$ gauge group is becoming weakly coupled. That is almost always true. We know that $i - p_i$ are the heights of boxes in the Young Tableaux. We can write $p_i + p'_i - i = i - (i - p_i) - (i - p'_i)$. Observe that this quantity can drop as i increases by one only if the heights $(i - p_i), (i - p'_i)$ simultaneously grow. If it drops twice in a row, it means we are at the top of the tableaux, where rows have length one. Then the heights of boxes will keep growing, and $p_i + p'_i - i$ have to keep decreasing. If $p_i + p'_i - i$ drops by one and then remains constant, or viceversa, it means one of the heights grew twice in a row, and then it will keep growing. Hence if $p_i + p'_i - i$ drops by one and then remains constant, or viceversa, it can only remain constant or decrease as i increases. Hence the only way $p_i + p'_i - i$ can go from 0 to -1 without remaining negative afterwards is through a sequence

$-1, 0, -1, 0, -1, \dots$. In all other cases, $p_i + p'_i - i$ will be nonnegative until $i = I$ and then remain negative. The exception corresponds to the sequences $p_i = (0, 1, 1, 2, 2, 3, 3, \dots)$ and $p'_i = (0, 1, 1, 2, 2, 3, 3, \dots)$ which add to $p_i + p'_i = (0, \mathbf{2}, 2, \mathbf{4}, 4, \mathbf{6}, 6, \dots)$. We marked the values of $p_i + p'_i = i$. We see combinations of mass parameters for even dimensions only.

Now we want to demonstrate that the decoupling gauge group in this case is a $USp(I)$ group. Let us take $N = 2M$ and a collision between punctures associated with two Young Tableaux with two columns of height M . If we turn off the mass parameters, the differentials on the three punctured sphere have overall degree of the poles $1 + 1 + 1 < 4, 1 + 1 + 2 < 6, 2 + 2 + 3 < 8, 2 + 2 + 4 < 10, \dots$, and are all zero! The theory has no Coulomb branch, and we are led to think it may be a free theory of hypermultiplets. If we turn on mass parameters at the full puncture, the differentials have degrees $1 + 1 + 2 = 4, 1 + 1 + 3 < 6, 2 + 2 + 4 = 8, 2 + 2 + 5 < 10, \dots$, and are nonzero, with coefficients given by Casimirs of a flavor group of even degree only. Call that group G_M . The theory should have an overall $SU(2) \times SU(2) \times G_M \sim SO(4) \times G_M$ symmetry. It would be very natural to have $G_M = USp(2M)$. If G_M was an orthogonal group, the hypermultiplets would have an extra $SU(2)$ flavor symmetry. The main constraint we need to satisfy is that G_M should be conformal. It is coupled to flavor currents from the remaining part of the theory, which had the anomaly of $2M$ fundamentals of $SU(2M)$. The hypothesis $G_M = USp(2M)$ passes the test! $USp(2M)$ is conformal when coupled to $2M + 2$ fundamentals (which have $SO(4M + 4)$ flavor symmetry).

As a simple example we can take the quiver with gauge groups $SU(2) \times SU(4) \times SU(6) \dots \times SU(2M)^{n-2M+4} \times \dots \times SU(4) \times SU(2)$, which has $n = 1$ basic punctures and two punctures of the type just analyzed. The very strongly coupled region where the two special punctures collide will give a new quiver gauge theory with gauge groups $SU(2) \times SU(3) \times SU(4) \dots \times SU(2M)^{n-2M+3} \times USp(2M)$, as depicted in figure 41 in the previous subsection. Such quiver admits a brane realization including a $O6$ plane, which could be used to test our claim. See section 5 for more references.

Next we should consider a setup with a Young Tableaux with two columns, each of length M , and a second Young Tableaux with two columns of different length $M - m$ and $M + m$. The decoupling gauge group should be a $USp(2M - 2m)$. The new puncture created by the collision has a Young Tableaux with $2M - 2m$ columns of height one, and 2 of height m . Consequently, it has a $U(1) \times SU(2) \times SU(2M - 2m)$ flavor symmetry. The $SU(2)$ flavor group matches the $SU(2)$ flavor symmetry of the original puncture with two columns of equal height. From a linear quiver realization of this puncture, we see that the $SU(2M - 2m)$ flavor symmetry has an anomaly corresponding to $2M - 2m + 2$ fundamentals. We are led to gauge a $USp(2M - 2m)$ subgroup of $SU(2M - 2m)$, as depicted in figure 41 in the previous subsection.

For more general pairs of Young Tableaux with two columns of different length and general N , the story is quite similar. The poles from the two punctures, after we remove the parameters for the $USp(I)$ gauge group add to the p_i for a Young Tableaux with several columns of height one, and two of different height. Typically this Tableau has either a $SU(I)$ flavor symmetry and $I + 2$ anomaly, and we gauge the $USp(I)$ subgroup of $SU(I)$.

As anticipated in the previous subsection, we can interpret this calculation as a pre-

diction that conformal linear quivers of unitary groups terminated at one or both ends by symplectic groups are part of the A_{N-1} class of theories, and are associated to spheres with two or four punctures with two columns, and several basic punctures. It would be interesting to verify this statement through the brane construction of [15] involving the M-theory lift of O6 planes.

As a simple example, we can produce the curve for $USp(2M)$ with $2M + 2$ flavors. The curve will make manifest a $SO(4) \times U(2M)$ subgroup of the theory. Take a sphere with two punctures associated to Young Tableaux with two columns of height m , a basic puncture and a full puncture. We will place the full puncture at infinity, the basic puncture at t_1 , the others at $0, 1$

$$x^{2M} = \sum_i x^{2M-2i} \frac{u_{2i}}{t^i(t-1)^i(t-t_1)} \quad (4.14)$$

To bring this curve to a more familiar form, we can map $4t = s + 2 + 1/s$, $y = xt(t-1) = 1/16(s-1/s)^2x$

$$(s + 1/s + 2 - 4t_1)y^{2M} = \sum_i 4u_{2i}y^{2M-2i} \quad (4.15)$$

In the $M = 2$ case we can have some fun with another Argyres-Seiberg duality. $USp(4)$ with 6 flavor should have a strong coupling limit dual as a $SU(2)$ gauge theory coupled to the E_7 SCFT. Indeed, if we collide the basic puncture with one of the two special punctures, we get $p_i = 1 + 1 = \mathbf{2}, 1 + 1 = \mathbf{2}, \mathbf{2} + 1 = \mathbf{3}$, and we see the u parameter for the decoupling $SU(2)$ gauge group, which gauges a subgroup of the $SU(4)$ subgroup of a full puncture. The $SU(2)$ commutes with a $SU(2) \times U(1) \in SU(4)$. We deduce that the A_3 theory with two full punctures and a puncture associated to a Young Tableaux with two columns of height 2 is the E_7 SCFT! The manifest flavor symmetry subgroups groups are a nice $SU(4) \times SU(4) \times SU(2) \in E_7$.

All in all, we found that the degeneration limits of a general linear superconformal quiver, possibly with symplectic groups at the end, are quite under control. They will in general require building blocks which correspond to three punctured spheres with two generic punctures and a full puncture. Such theories can be constructed from the linear quivers with two generic punctures and $N - 1$ basic ones, bringing together the $N - 1$ basic punctures into a full one.

On the other hand, not all possible theories associated with Riemann surfaces and generic punctures can be built that way. A theory associated to a three-punctured sphere with three generic punctures admits no construction of the type outlined until now. There are indications that such a theory could be produced from T_N by giving expectation values to fields in the Higgs branch, and flowing to the IR. We will not follow that lead in this paper. Similarly, we could consider a theory associated to a four-punctured sphere, with punctures chosen in such a way that every degeneration limit will produce a theory with three non-full punctures. For a fixed rank N , these unconstructible theories are a finite set. Most choices of a Riemann surface and punctures will lead to theories which in every degeneration limit decompose into three punctured sphere theories with at least a full puncture, which are constructible.

5. Further developements

It would be very natural to extend this work to other class of theories which admit a brane construction, and can be associated to the six-dimensional $(2, 0)$ theory. The work of [6] has been extended in various ways. O6 planes have been used to add symplectic gauge groups at the end(s) of linear quivers of unitary gauge groups, but also to add matter in the antisymmetric representation [15]. The M-theory lift still involves M5 branes with a A_{N-1} $(2, 0)$ theory on the worldvolume. We found in our analysis that the addition of symplectic groups at the end(s) of a quiver indeed leads to standard theories of the A_{N-1} type, with appropriate punctures. It would be interesting to check that the same is true for adding antisymmetry matter representations.

Furthermore, linear quivers of (alternating) orthogonal and symplectic groups have been engineered by adding a O4 plane [16] [17]. There are really two cases, one involving even orthogonal groups, the other involving odd orthogonal groups. The former case appears to involve the D type $(2, 0)$ theory. It would be straightforward to classify the possible defects for the D type theory, along analogous lines to our work. The latter case appears to involve a SW curve constrained by $t \rightarrow -t$. A map $t' = t^2$ may lead to a SW curve of the A_{N-1} type, with defects at $t' = 0, \infty$ which make the differentials of odd degree antiperiodic. Again, more work would be needed to fully understand the situation.

In principle one could also consider E type of $(2, 0)$ theory. At the degeneration limits of the base Riemann surface weakly coupled exceptional gauge symmetries should appear, conformally coupled to non-trivial SCFTs with exceptional flavor symmetries. It would be interesting to study the problem, and identify admissible punctures, and corresponding flavor symmetries.

Finally, one can try adding orbifold fiveplanes to the standard brane setup. This should lead to quivers of unitary groups in the shape of D-type Dynkin diagrams. (see [14] for related, three-dimensional setup). It would be interesting to realize those constructions in detail, and identify which sort of defects in the A_{N-1} theory they lead to.

We have no idea of how to attack the case of quivers of unitary groups in the shape of E type Dynkin diagrams.

Acknowledgments

We would like to thank J. Maldacena, G. Moore, A. Neitzke, Y. Tachikawa, N. Seiberg and E. Witten for discussions. D.G. is supported in part by the DOE grant DE-FG02-90ER40542 and in part by the Roger Dashen membership in the Institute for Advanced Study.

References

- [1] N. Seiberg and E. Witten, “Monopoles, duality and chiral symmetry breaking in N=2 supersymmetric QCD,” *Nucl. Phys.* **B431** (1994) 484–550, [arXiv:hep-th/9408099](#).
- [2] P. C. Argyres, M. R. Plesser, and A. D. Shapere, “The Coulomb phase of N=2 supersymmetric QCD,” *Phys. Rev. Lett.* **75** (1995) 1699–1702, [arXiv:hep-th/9505100](#).

- [3] P. C. Argyres and N. Seiberg, “S-duality in N=2 supersymmetric gauge theories,” *JHEP* **12** (2007) 088, [arXiv:0711.0054 \[hep-th\]](#).
- [4] H. Lin, O. Lunin, and J. M. Maldacena, “Bubbling AdS space and 1/2 BPS geometries,” *JHEP* **10** (2004) 025, [arXiv:hep-th/0409174](#).
- [5] D. Gaiotto and J. Maldacena *To appear*.
- [6] E. Witten, “Solutions of four-dimensional field theories via M- theory,” *Nucl. Phys.* **B500** (1997) 3–42, [arXiv:hep-th/9703166](#).
- [7] D. Gaiotto, G. Moore, and A. Neitzke *To appear*.
- [8] P. C. Argyres and A. Buchel, “New S-dualities in N = 2 supersymmetric SU(2) x SU(2) gauge theory,” *JHEP* **11** (1999) 014, [arXiv:hep-th/9910125](#).
- [9] A. Mikhailov, “BPS states and minimal surfaces,” *Nucl. Phys.* **B533** (1998) 243–274, [arXiv:hep-th/9708068](#).
- [10] N. Dorey, V. V. Khoze, and M. P. Mattis, “On N = 2 supersymmetric QCD with 4 flavors,” *Nucl. Phys.* **B492** (1997) 607–622, [arXiv:hep-th/9611016](#).
- [11] J. Bhattacharya, S. Bhattacharyya, S. Minwalla, and S. Raju, “Indices for Superconformal Field Theories in 3,5 and 6 Dimensions,” *JHEP* **02** (2008) 064, [arXiv:0801.1435 \[hep-th\]](#).
- [12] O. Aharony, M. Berkooz, and N. Seiberg, “Light-cone description of (2,0) superconformal theories in six dimensions,” *Adv. Theor. Math. Phys.* **2** (1998) 119–153, [hep-th/9712117](#).
- [13] S. Gukov and E. Witten, “Gauge theory, ramification, and the geometric langlands program,” [arXiv:hep-th/0612073](#).
- [14] D. Gaiotto and E. Witten, “S-Duality of Boundary Conditions In N=4 Super Yang-Mills Theory,” [arXiv:0807.3720 \[hep-th\]](#).
- [15] P. C. Argyres, R. Maimon, and S. Pellaud, “The M theory lift of two O6- planes and four D6 branes,” *JHEP* **05** (2002) 008, [arXiv:hep-th/0204127](#).
- [16] A. Brandhuber, J. Sonnenschein, S. Theisen, and S. Yankielowicz, “M-theory and Seiberg-Witten curves: Orthogonal and symplectic groups,” *Nucl. Phys.* **B504** (1997) 175–188, [arXiv:hep-th/9705232](#).
- [17] K. Landsteiner, E. Lopez, and D. A. Lowe, “N = 2 supersymmetric gauge theories, branes and orientifolds,” *Nucl. Phys.* **B507** (1997) 197–226, [arXiv:hep-th/9705199](#).